

Direct Operated Precision Regulator

● **Sensitivity: Within 0.2% F.S.**

● **Energy saving, Air consumption:**

80% reduction (SMC comparison)

Reduced to **0.8 l/min** from 4 to 6 l/min in the existing product (ARP3000).

* Comparison under the same condition of P2 = 0.3 MPa

● **Repeatability: Within ±1% F.S. (or within ±3 kPa*)**

* For 0.2 MPa setting

● **With backflow function** (ARP20K/30K/40K)

Installable between a solenoid valve and a cylinder

● **Expanded lineup** ●

3 types of set pressure and the body size allow more freedom in designing a circuit.

Model	ARP20(K)	ARP30(K)	ARP40(K)	
Setting	0.2 MPa	▲	▲	▲
	0.4 MPa	●	●	●
	0.6 MPa	▲	▲	▲
Port size	1/8	●	—	—
	1/4	●	●	●
	3/8	—	●	●
	1/2	—	—	●

● : Standard ▲ : Semi-standard

Direct operated precision regulator now available as a series!! (ARP20/30/40)

Applications

a Application of a constant pressure to the fluid.

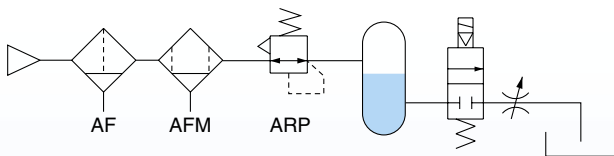

b Adjustment of the blow-line pressure.

Sensitivity within 0.2% F.S. allows a more precise pressure adjustment.

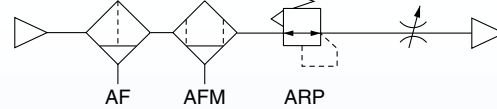

c Control of a clamping force by a precise pressure control.

Sensitivity within 0.2% F.S. allows a more precise pressure adjustment. Repeatability within ±1% F.S. (or within ±0.3 kPa) allows a constant clamping force.

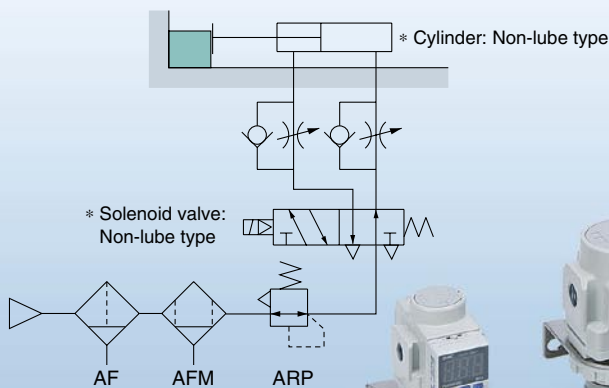

d Release of the residual pressure with the backflow function.

● **Residual pressure circuit**

Also exhausts the residual pressure completely.

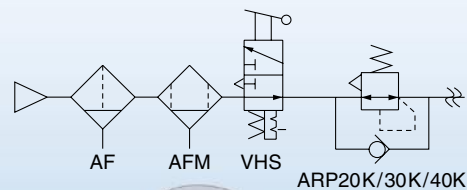

When the air supply is cut off and releasing the inlet pressure to the atmosphere, the residual pressure release of the outlet side can be ensured for a safety purpose.



Series **ARP20/30/40**



CAT.EUS40-52A-UK

Direct Operated Precision Regulator/Modular Style

ARP20 to ARP40

Direct Operated Precision Regulator with Backflow Function/Modular Style

ARP20K to ARP40K

JIS symbol

Regulator Regulator with backflow function

- With the backflow function it incorporates a mechanism to exhaust the air pressure in the outlet side reliably and quickly.

Example 1)
When the pressure in the rear and the front of the cylinder differs:

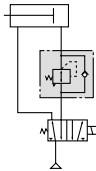

Example 2)
When the air supply is cut off and releasing the inlet pressure to the atmosphere, the residual pressure release of the outlet side can be ensured for a safety purpose.

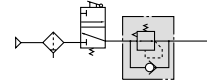

How to Order

ARP **30** **K** - **03** **BE** -

① ② ③ ④ ⑤ ⑥

- Option / Semi-standard: Select one each for a to f.
 - Option / Semi-standard symbol: Enter them alphanumerically.
- Example) ARP30K-03BE-1RY

	Symbol	Description	① Body size				
			20	30	40		
② With backflow function	—	Without backflow function	●	●	●		
	K	With backflow function	●	●	●		
③ Thread type	+						
	—	Rc	●	●	●		
	N	NPT	●	●	●		
④ Port size	F	G	●	●	●		
	+						
	01	1/8	●	—	—		
	02	1/4	●	●	●		
⑤ Option	a Mounting	03	3/8	—	●	●	
		04	1/2	—	—	●	
		+					
	b Digital pressure switch	—	Without mounting option	●	●	●	
		B ^{Note 2)}	With bracket	●	●	●	
		H	With set nut (For panel mount)	●	●	●	
		+					
		Pressure gauge	—	Without pressure gauge	●	●	●
			E	Square embedded type pressure gauge (With limit indicator)	●	●	●
			G	Round type pressure gauge (With limit indicator)	●	●	●
Digital pressure switch	E1 ^{Note 3)}	Output: NPN output / Electrical entry: Wiring bottom entry	●	●	●		
	E2 ^{Note 3)}	Output: NPN output / Electrical entry: Wiring top entry	●	●	●		
	E3 ^{Note 3)}	Output: PNP output / Electrical entry: Wiring bottom entry	●	●	●		
	E4 ^{Note 3)}	Output: PNP output / Electrical entry: Wiring top entry	●	●	●		

Direct Operated Precision Regulator/Modular Style *Series ARP20 to ARP40*

Direct Operated Precision Regulator with Backflow Function/Modular Style *Series ARP20K to ARP40K*



ARP20/ARP20K

ARP30/ARP30K

ARP40/ARP40K

		Symbol	Description	①			
				Body size			
				20	30	40	
⑥	c	Set pressure	—	0.005 to 0.4 MPa setting	●	●	●
			1 <small>Note 4)</small>	0.005 to 0.2 MPa setting	●	●	●
			3 <small>Note 4)</small>	0.008 to 0.6 MPa setting	●	●	●
	+						
	d	Flow direction	—	Flow direction: Left to right	●	●	●
			R	Flow direction: Right to left	●	●	●
	+						
	e	Knob	—	Downward facing knob	●	●	●
			Y	Upward facing knob	●	●	●
	+						
	f	Pressure unit	—	Name plate and pressure gauge in imperial units: MPa	●	●	●
			Z <small>Note 5)</small>	Name plate and pressure gauge in imperial units: psi	○ <small>Note 7)</small>	○ <small>Note 7)</small>	○ <small>Note 7)</small>
ZA <small>Note 6)</small>			Digital pressure switch: With unit conversion function	△ <small>Note 8)</small>	△ <small>Note 8)</small>	△ <small>Note 8)</small>	

Note 1) Options B, G, H are shipped together, (but not assembled).

Note 2) Set nut is included for bracket.

Note 3) When choosing with H (panel mount), the installation space for the lead wires will not be secured. In this case, select "wiring top entry" for the lead wire entry. (Select "wiring bottom entry" when the semi-standard Y is chosen simultaneously.)

Note 4) The only difference from the standard specifications is the pressure regulator spring.

It does not restrict the setting of 0.2 MPa/0.6 MPa or more.

When the pressure gauge is attached, a 0.2 MPa pressure gauge for a 0.2 MPa setting will be fitted, and a 0.7 MPa pressure gauge for a 0.6 MPa setting will be fitted.

When a digital pressure switch is attached, the pressure display is fixed to 1.0 MPa.

Note 5) For thread type: NPT. This product is for overseas use only according to the new Measurement Law. (The SI unit type is provided for use in Japan.) The digital pressure switch will be equipped with the unit conversion function, setting to psi initially.

Note 6) For options: E1, E2, E3, E4. This product is for overseas use only according to the new Measurement Law. (The SI unit is provided for use in Japan.)

Note 7) ○: For thread type: NPT only

Note 8) △: Combination available for options: E1, E2, E3, E4.

Direct Operated Precision Regulator/Modular Style (For Special Applications)

¹⁰/₂₁-ARP20 to ¹⁰/₂₁-ARP40

Direct Operated Precision Regulator with Backflow Function/Modular Style (For Special Applications)

¹⁰/₂₁-ARP20K to ¹⁰/₂₁-ARP40K

JIS symbol

Regulator Regulator with backflow function

- Clean room compliant (10-ARP).
- Copper-free, fluorine-free (20-ARP).
- Clean room compliant, copper-free, fluorine-free, silicon-free (21-ARP).
- With the backflow function it incorporates a mechanism to exhaust the air pressure in the outlet side reliably and quickly.

Example 1)
When the pressure in the rear and the front of the cylinder differs:

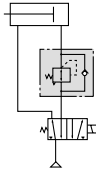

Example 2)
When the air supply is cut off and releasing the inlet pressure to the atmosphere, the residual pressure release of the outlet side can be ensured for a safety purpose.

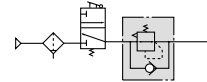

How to Order

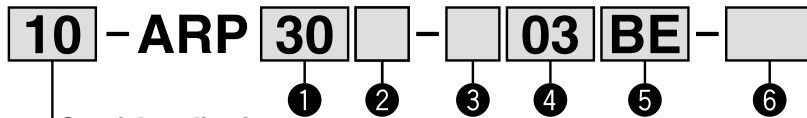

Special applications

10	Clean room compliant
20	Copper-free, fluorine-free
21	Clean room compliant, copper-free, fluorine-free, silicon-free

Clean room compliant	<ul style="list-style-type: none"> • Less particle generation in a clean room • Grease: Fluorine type • Packaging: Double packaging
Copper-free, fluorine-free	<ul style="list-style-type: none"> • Wetted parts: Aluminum die-cast, Stainless steel, HNBR, NBR • Grease: Lithium soap base type
Clean room compliant, copper-free, fluorine-free, silicon-free	<ul style="list-style-type: none"> • Less particle generation in a clean room • Wetted parts: Aluminum die-cast, Stainless steel, HNBR, NBR • Grease: Lithium soap base type

- Option / Semi-standard: Select one each for a to f.
 - Option / Semi-standard symbol: Enter them alphanumerically.
- Example) 10-ARP30K-03BE-1RY

Clean room compliant	Copper-free, fluorine-free	Clean room compliant, copper-free, fluorine-free, silicon-free
----------------------	----------------------------	--

	Symbol	Description	① Body size			① Body size			① Body size			
			20	30	40	20	30	40	20	30	40	
② With backflow function	—	Without backflow function	●	●	●	●	●	●	●	●	●	
	K	With backflow function	●	●	●	●	●	●	●	●	●	
③ Thread type	—	Rc	●	●	●	●	●	●	●	●	●	
	N	NPT	●	●	●	●	●	●	●	●	●	
	F	G	●	●	●	●	●	●	●	●	●	
④ Port size	01	1/8	●	—	—	●	—	—	●	—	—	
	02	1/4	●	●	●	●	●	●	●	●	●	
	03	3/8	—	●	●	—	●	●	—	●	●	
	04	1/2	—	—	●	—	—	●	—	—	●	
a Mounting	—	Without mounting option	●	●	●	●	●	●	●	●	●	
	B ^{Note 2)}	With bracket	●	●	●	●	●	●	●	●	●	
	H	With set nut (For panel mount)	●	●	●	●	●	●	●	●	●	
⑤ Option ^{Note 1)}	b Pressure gauge	—	Without pressure gauge	●	●	●	●	●	●	●	●	●
		G	Round type pressure gauge (Without limit indicator)	●	●	●	—	—	—	●	●	●
	Digital pressure switch	E1 ^{Note 3)}	Output: NPN output / Electrical entry: Wiring bottom entry	—	—	—	●	●	●	—	—	—
		E2 ^{Note 3)}	Output: NPN output / Electrical entry: Wiring top entry	●	●	●	—	—	—	—	—	—
		E3 ^{Note 3)}	Output: PNP output / Electrical entry: Wiring bottom entry	●	●	●	—	—	—	—	—	—
E4 ^{Note 3)}	Output: PNP output / Electrical entry: Wiring top entry	●	●	●	—	—	—	—	—	—		

Direct Operated Precision Regulator *Series* ¹⁰/₂₀-ARP20 to ¹⁰/₂₁-ARP40 (For Special Applications)

Direct Operated Precision Regulator with Backflow Function (For Special Applications) *Series* ¹⁰/₂₁-ARP20K to ¹⁰/₂₁-ARP40K



¹⁰/₂₀/₂₁-ARP20/ARP20K

¹⁰/₂₀/₂₁-ARP30/ARP30K

¹⁰/₂₀/₂₁-ARP40/ARP40K

		Symbol	Description	①			
				Body size			
				20	30	40	
⑥	c	Set pressure	—	0.005 to 0.4 MPa setting	●	●	●
			1 ^{Note 4)}	0.005 to 0.2 MPa setting	●	●	●
			3 ^{Note 4)}	0.008 to 0.6 MPa setting	●	●	●
		+					
	d	Flow direction	—	Flow direction: Left to right	●	●	●
			R	Flow direction: Right to left	●	●	●
	+						
	e	Knob	—	Downward facing knob	●	●	●
			Y	Upward facing knob	●	●	●
	+						
	f	Pressure unit	—	Name plate and pressure gauge in SI units: MPa	●	●	●
			Z ^{Note 5)}	Name plate and pressure gauge in imperial units: psi	○ ^{Note 7)}	○ ^{Note 7)}	○ ^{Note 7)}
ZA ^{Note 6)}			Digital pressure switch: With unit conversion function	△ ^{Note 8)}	△ ^{Note 8)}	△ ^{Note 8)}	

Note 1) Options B, G, H are shipped together, (but not assembled).

Note 2) Set nut is included for bracket.

Note 3) When choosing with H (panel mount), the installation space for the lead wires will not be secured. In this case, select "wiring top entry" for the lead wire entry. (Select "wiring bottom entry" when the semi-standard Y is chosen simultaneously.)

Note 4) The only difference from the standard specifications is the pressure regulator spring.
It does not restrict the setting of 0.2 MPa/0.6 MPa or more.
When the pressure gauge is attached, a 0.2 MPa pressure gauge for a 0.2 MPa setting will be fitted, and a 0.7 MPa pressure gauge for a 0.6 MPa setting will be fitted.

Note 5) For thread type: NPT. This product is for overseas use only according to the new Measurement Law. (The SI unit type is provided for use in Japan.) The digital pressure switch will be equipped with the unit conversion function, setting to psi initially.

Note 6) For options: E1, E2, E3, E4. This product is for overseas use only according to the new Measurement Law. (The SI unit is provided for use in Japan.)

Note 7) ○: For thread type: M5 and NPT only

Note 8) △: Combination available for options: E1, E2, E3, E4.

Series ARP20/30/40

Specifications

Model			ARP20(K)	ARP30(K)	ARP40(K)
Port size			1/8, 1/4	1/4, 3/8	1/4, 3/8, 1/2
Fluid			Air		
Proof pressure			1.2 MPa		
Max. operating pressure			0.7 MPa		
Set pressure range <small>Note 1)</small>	For 0.4 MPa setting	Ex.) ARP30-02BG	0.005 to 0.4 MPa		
	For 0.2 MPa setting	Ex.) ARP30-02BG-1	0.005 to 0.2 MPa		
	For 0.6 MPa setting	Ex.) ARP30-02BG-3	0.008 to 0.6 MPa		
Sensitivity			Within 0.2% F.S.		
Repeatability <small>Note 2)</small>			Within $\pm 1\%$ F.S. (or ± 3 kPa)		
Air consumption	For 0.4 MPa setting	Ex.) ARP30-02BG	1 ℓ /min (ANR) or less (at P2 = 0.4 MPa)		
	For 0.2 MPa setting	Ex.) ARP30-02BG-1	0.6 ℓ /min (ANR) or less (at P2 = 0.2 MPa)		
	For 0.6 MPa setting	Ex.) ARP30-02BG-3	1.4 ℓ /min (ANR) or less (at P2 = 0.6 MPa)		
Pressure port size <small>Note 3)</small>			1/8	1/8	1/4
Ambient and fluid temperature			-5 to 60°C (No freezing)		
	With digital pressure switch	Ex.) ARP30-02BE1	-5 to 50°C (No freezing)		
Construction			Bleed type		
Weight (kg) <small>Note 4)</small>			0.2	0.3	0.5

Note 1) When a product with the backflow function (ARP20K to 40K) is chosen, set the inlet pressure to 0.05 MPa or higher than the set pressure.

Note 2) For the type set to 0.2 MPa only, repeatability will be within ± 3 kPa.

Note 3) Port thread is not provided for products with square embedded-type pressure gauges.

Note 4) Weight shown is for products without any options.

Direct Operated Precision Regulator/Modular Style *Series ARP20/30/40*

Optional Parts

Standard

Model		ARP20(K)	ARP30(K)	ARP40(K)	
Bracket assembly ^{Note 1)}		ARP20P-270AS	ARP30P-270AS	ARP40P-270AS	
Set nut		ARP20P-260S	ARP30P-260S	ARP40P-260S	
Pressure gauge	0.4 MPa	Round type ^{Note 2)}	G36-4-□01		
		Square embedded type ^{Note 3)}	GC3-4AS [GC3P-010AS (Pressure gauge cover only)]		
	0.2 MPa	Round type ^{Note 2)}	G36-2-□01		
		Square embedded type ^{Note 3)}	GC3-2AS [GC3P-010AS (Pressure gauge cover only)]		
	0.7 MPa	Round type ^{Note 2)}	G36-7-□01		
		Square embedded type ^{Note 3)}	GC3-7AS [GC3P-010AS (Pressure gauge cover only)]		
	Digital type ^{Note 4)}	NPN output / Wiring bottom entry		ISE35-N-25-MLA [ISE35-N-25-M (Switch body only)]	
		NPN output / Wiring top entry		ISE35-R-25-MLA [ISE35-R-25-M (Switch body only)]	
PNP output / Wiring bottom entry		ISE35-N-65-MLA [ISE35-N-65-M (Switch body only)]			
PNP output / Wiring top entry		ISE35-R-65-MLA [ISE35-R-65-M (Switch body only)]			

Clean Room Compliant (10-)

Model		10-ARP20(K)	10-ARP30(K)	10-ARP40(K)	
Bracket assembly ^{Note 1)}		ARP20P-270AS	ARP30P-270AS	ARP40P-270AS	
Set nut		ARP20P-260S	ARP30P-260S	ARP40P-260S	
Pressure gauge	0.4 MPa	Round type ^{Note 2)}	G49-4-□01		
	0.2 MPa		G49-2-□01		
	0.7 MPa		G49-7-□01		
	Digital type ^{Note 4)}	NPN output / Wiring bottom entry		ISE35-N-25-MLA [ISE35-N-25-M (Switch body only)]	
		NPN output / Wiring top entry		ISE35-R-25-MLA [ISE35-R-25-M (Switch body only)]	
		PNP output / Wiring bottom entry		ISE35-N-65-MLA [ISE35-N-65-M (Switch body only)]	
PNP output / Wiring top entry		ISE35-R-65-MLA [ISE35-R-65-M (Switch body only)]			

Copper-free, Fluorine-free (20-)

Model		20-ARP20(K)	20-ARP30(K)	20-ARP40(K)
Bracket assembly ^{Note 1)}		ARP20P-270AS	ARP30P-270AS	ARP40P-270AS
Set nut		ARP20P-260S	ARP30P-260S	ARP40P-260S
Pressure gauge	0.4 MPa	Round type ^{Note 2)}	G46-4-□01-X3	
	0.2 MPa		G46-2-□01-X3	
	0.7 MPa		G46-7-□01-X3	

Clean Room Compliant, Copper-free, Fluorine-free (21-)

Model		21-ARP20(K)	21-ARP30(K)	21-ARP40(K)
Bracket assembly ^{Note 1)}		ARP20P-270AS	ARP30P-270AS	ARP40P-270AS
Set nut		ARP20P-260S	ARP30P-260S	ARP40P-260S
Pressure gauge	0.4 MPa	Round type ^{Note 2)}	G49-4-□01MS-X3	
	0.2 MPa		G49-2-□01MS-X3	
	0.7 MPa		G49-7-□01MS-X3	

Note 1) Assembly includes a bracket and set nuts.

Note 2) □ in part numbers for a round-type pressure gauge indicates a type of connection thread. No indication is necessary for R; however, indicate N for NPT. The G thread is unavailable. If it is required, select the R thread type (—) instead. Please contact SMC regarding the connection thread NPT and the pressure gauge supply for psi unit specifications.

Note 3) Includes one O-ring and 2 mounting screws. []: Pressure gauge cover only.

Note 4) Lead wire with connector (2 m), adapter, lock pin, O-ring (1 pc.), and mounting screws (2 pcs.) are included. []: Switch body only.
For how to order the digital pressure switch, refer to the following specific page for the digital pressure switch.

Series ARP20/30/40

Condition:
Inlet pressure 0.7 MPa

Conditions:
Inlet pressure 0.5 MPa
Outlet pressure 0.2 MPa
Flow rate 20 ℓ/min (ANR)

Flow Characteristics (Representative values)

ARP20(K)

Rc1/4

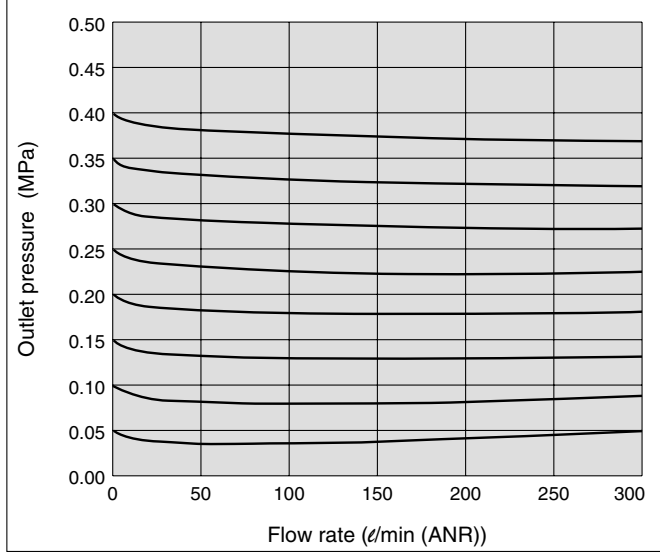

ARP20(K)

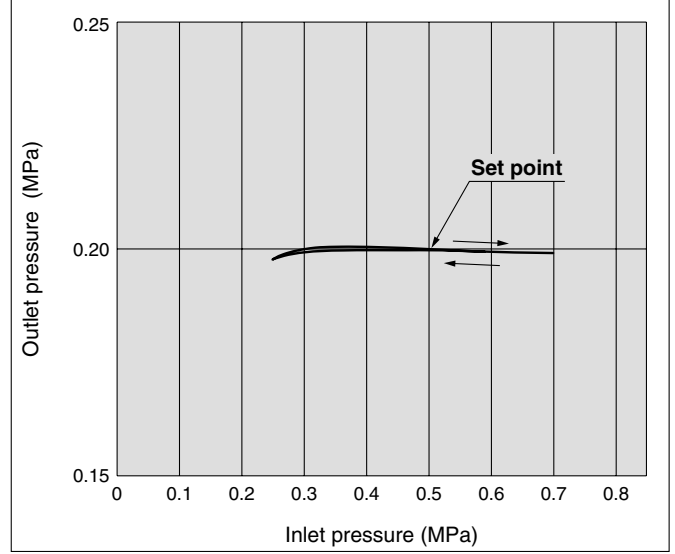

ARP30(K)

Rc3/8

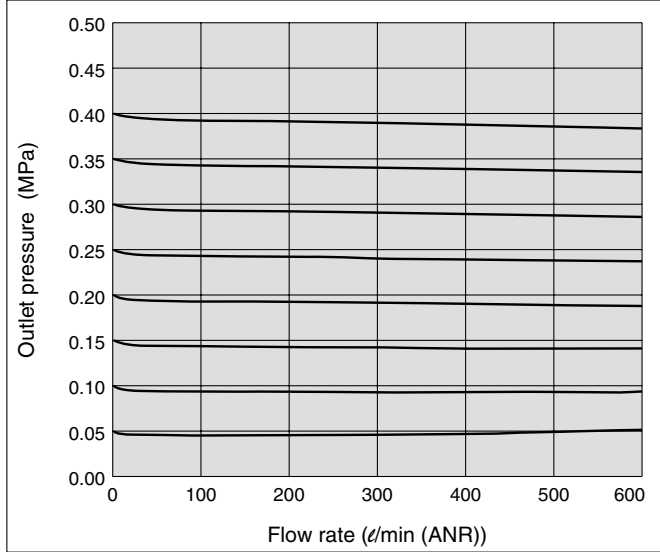

ARP30(K)

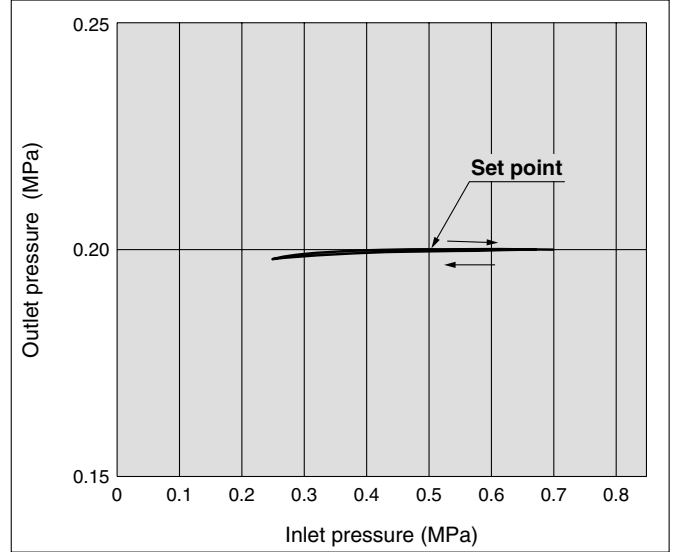

ARP40(K)

Rc1/2

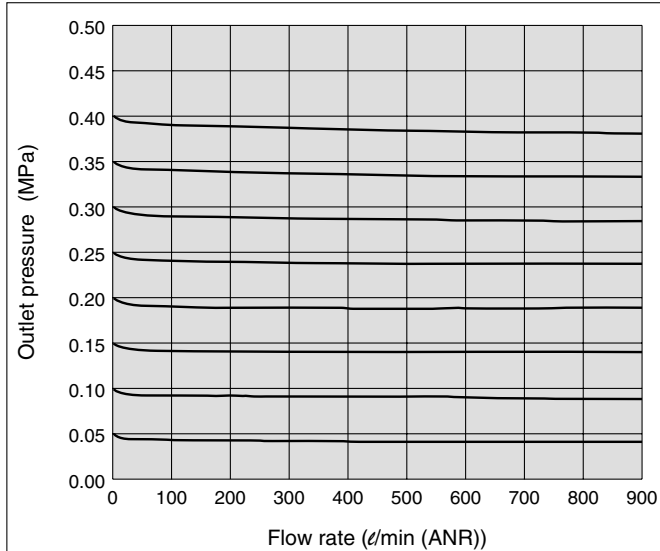

ARP40(K)

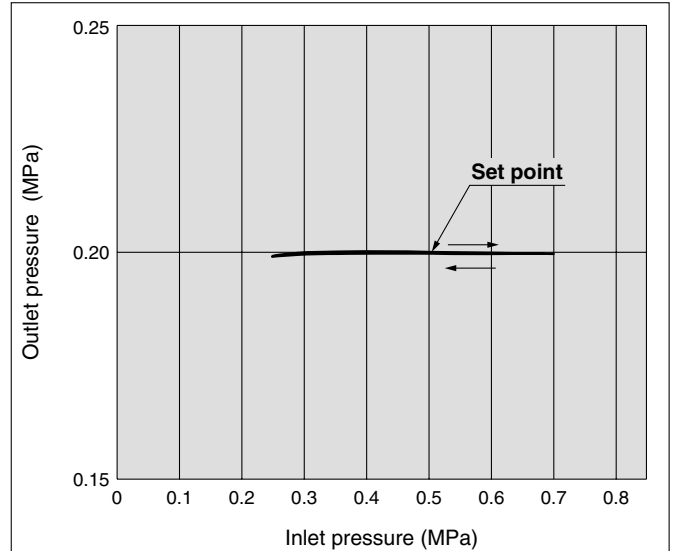

Direct Operated Precision Regulator/Modular Style *Series ARP20/30/40*

Construction

ARP20(K)/30(K)/40(K)

ARP20K/30K/40K (With backflow function)

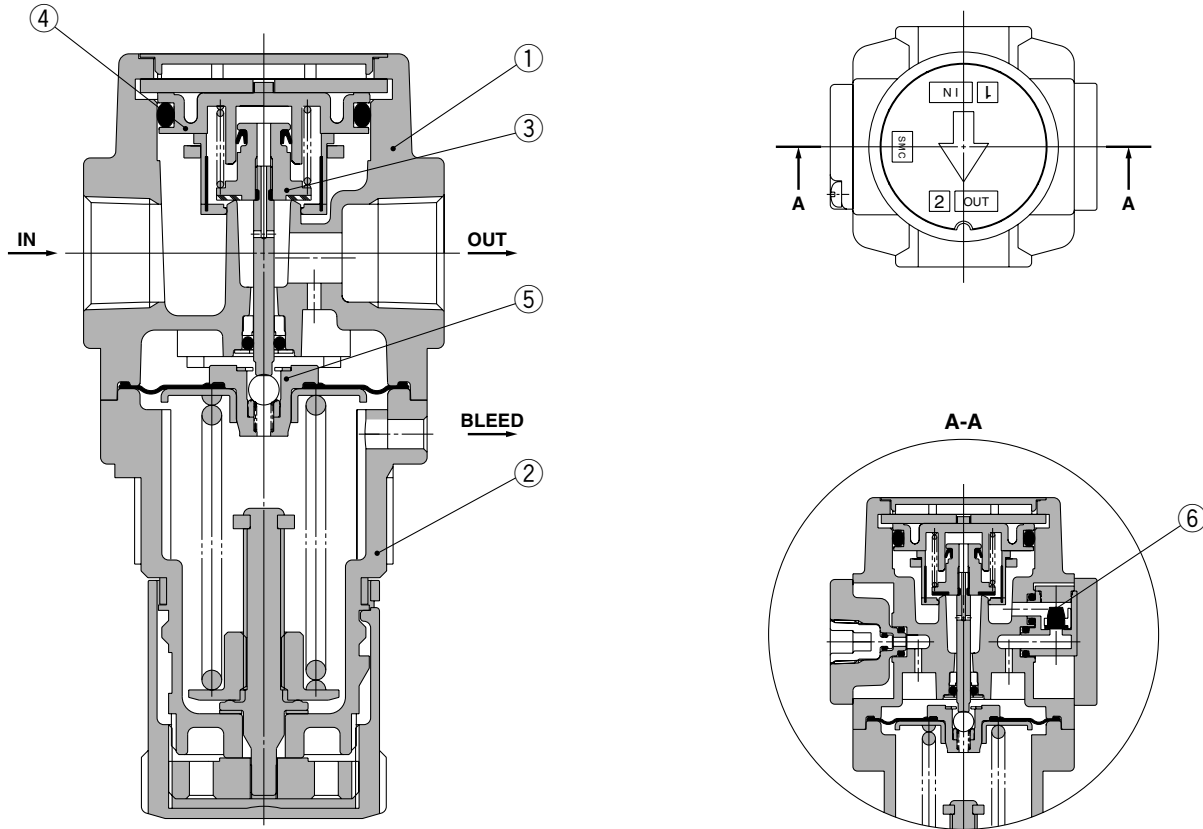

Component Parts

No.	Description	Material	Note
1	Body	Aluminum die-casted	External color: White
2	Bonnet	Polyacetal	External color: White

Replacement Parts

No.	Description	Material	Part no.		
			ARP20(K)	ARP30(K)	ARP40(K)
3	Valve assembly	Brass, HNBR, NBR	ARP20P-330AS	ARP30P-330AS	ARP40P-330AS
4	Valve guide assembly	Polyacetal, NBR	ARP20P-050AS	ARP30P-050AS	ARP40P-050AS
5	Diaphragm assembly	HNBR, Stainless steel, Brass	ARP20P-151AS	ARP30P-151AS	ARP40P-151AS
6 Note)	Check valve assembly	—	AR20KP-020AS		

Note) The check valve assembly is the replacement part for a regulator with a backflow function (ARP20K to 40K), and it is made up of check valve body assembly, the check valve cover and 2 screws.

* Please consult SMC for special application specifications.

Series ARP20/30/40

Working Principle (Regulator with Backflow Function)

ARP20K/30K/40K

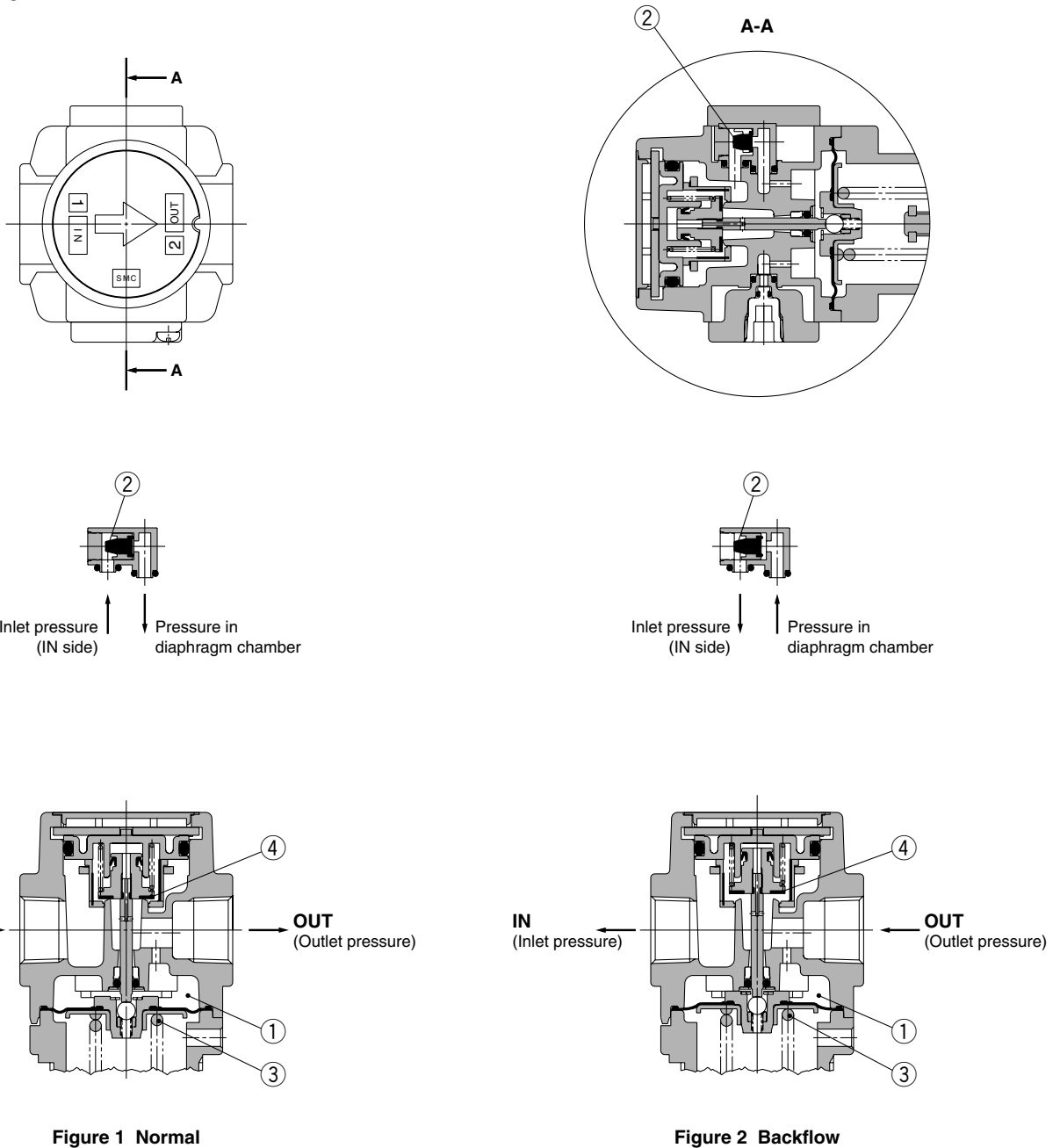

When the inlet pressure is higher than the set pressure, the check valve ② closes and operates as a normal regulator (Figure 1). When the inlet pressure is shut off and released, the check valve ② opens and the pressure in the diaphragm chamber ① is released to the inlet side (Figure 2). This lowers the pressure in the diaphragm chamber ① and the force generated by the pressure regulator spring ③ pushes down the diaphragm. Valve ④ opens through the stem, and the outlet pressure is released to the inlet side (Figure 2).

Direct Operated Precision Regulator/Modular Style *Series ARP20/30/40*

Dimensions

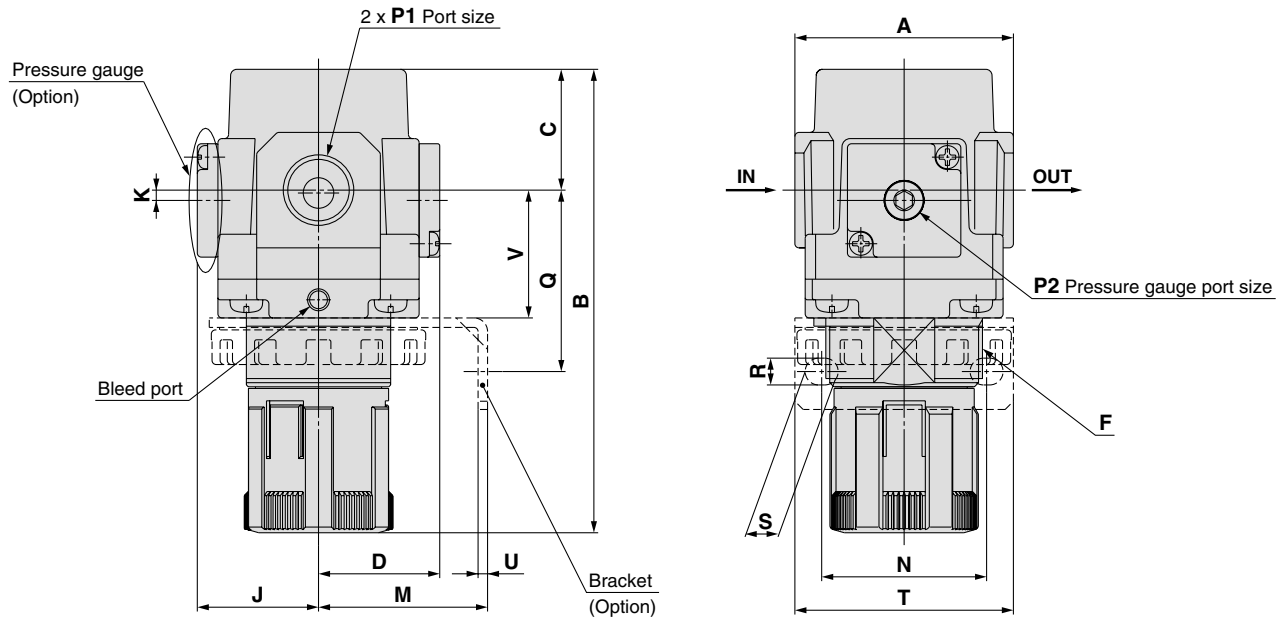

Panel fitting dimension

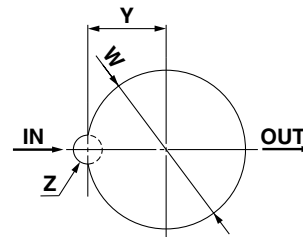

* The dimensions are for special applications (not including round-type pressure gauge). The dimensions for special applications are the same as those of the standard product. However, as for the 10-, 20-series, a fitting is attached to the bleed port and it protrudes from the face with the OUT port by approx. 11 mm.

Plate thickness
 ARP20(K), ARP30(K): Max. 3.5
 ARP40(K): Max. 5

Pressure Gauge Option

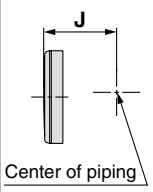
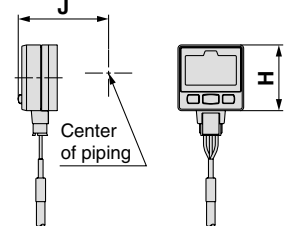
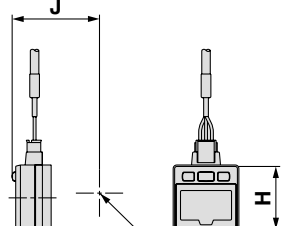
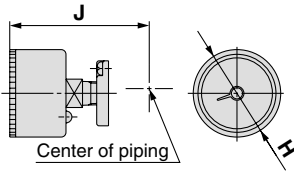
Option	Square embedded type pressure gauge	Digital pressure switch (Electrical entry: Wiring bottom entry)	Digital pressure switch (Electrical entry: Wiring top entry)	Round type pressure gauge
Dimensions				

Model	Standard specifications								
	P1	P2	A	B ^{Note 1)}	C	D	F	J	K
ARP20(K)	1/8, 1/4	1/8	40	98	27	28.5	M28 x 1	28.5 ^{Note 2)}	2
ARP30(K)	1/4, 3/8	1/8	53	117	29	29.5	M38 x 1.5	29.5	2.5
ARP40(K)	1/4, 3/8, 1/2	1/4	70	148	41	34	M42 x 1.5	34	1

Model	Optional specifications																
	Square embedded type pressure gauge		Digital pressure switch		Round type pressure gauge ^{Note 3)}		Bracket mount dimension							Panel mount			
	H	J	H	J	H	J	M	N	Q	R	S	T	U	V	W	Y	Z
ARP20(K)	□28	29.5	□27.8	40	ø37.5	66	30	34	47	5.4	15.4	55	2.3	28	28.5	14	6
ARP30(K)	□28	30.5	□27.8	41	ø37.5	67	41	40	44	6.5	8	53	2.3	31	38.5	19	7
ARP40(K)	□28	35	□27.8	45	ø42.5	74	50	54	54	8.5	10.5	70	2.3	35.5	42.5	21	7

Note 1) The total length of B direction is the length when the filter regulator knob is unlocked.

Note 2) For ARP20(K) only, the position of the pressure gauge is above the center of the piping.

Note 3) For dimensions of the round-type pressure gauge for special applications, please contact SMC.

Options

Digital Pressure Switch

ISE35-**N**-**25**-**M****L****A**

① ② ③ ④ ⑤

	Symbol	Description
① Electrical entry	N	Wiring bottom entry
	R	Wiring top entry
② Output	25	NPN output
	65	PNP output
③ Unit <small>Note 1)</small>	<small>Note 2)</small>	With unit conversion function
	M	Fixed SI unit
	P <small>Note 2)</small>	Pressure unit: psi (Initial value), with unit conversion function
④ Lead wire	—	Without lead wire
	L	Lead wire with connector (2 m)
⑤ Accessories	—	Without accessories (Switch body only)
	A	With accessories (Adapter, O-ring: 1 pc., Mounting screw: 2 pcs., Lock pin)

Note 1) Under the New Measurement Law, the sales of switches with the unit switching function have not been allowed for use in Japan.
 Note 2) Unit name plate is attached.
 Note 3) Operation manual is included.
 Note 4) When ordering the body only, select the symbol from ① to ⑤ respectively.

Specifications

Rated pressure range	0 to 1 MPa	
Set pressure range	-0.1 to 1 MPa	
Withstand pressure	1.5 MPa	
Set pressure resolution	0.01 MPa	
Power supply voltage	12 to 24 VDC, Ripple (p-p) 10% or less (with power supply polarity protection)	
Current consumption	55 mA or less (at no load)	
Switch output	NPN or PNP open collector 1 output	
Maximum load current	80 mA	
Maximum applied voltage	30 V (at NPN output)	
Residual voltage	1 V or less (with load current of 80 mA)	
Response time	1 s	
Anti-chattering function	(0.25, 0.5, 2, 3)	
Short-circuit protection	Yes	
Repeatability	±1% F.S. or less	
Hysteresis	Hysteresis mode	Variable (0 or above)
	Window comparator mode	
Display	3-digit, 7-segment indicator, 2-color display (Red/Green) can be interlocked with the switch output.	
Display accuracy	±2% F.S.±1 digit (25°C±3°C)	
Indicator light	Light up when output is turned ON. (Green)	
Environment resistance Enclosure	IP40	
Lead wire with connector	φ3.4 3-wire 25AWG 2 m	

Digital Pressure Switch Construction

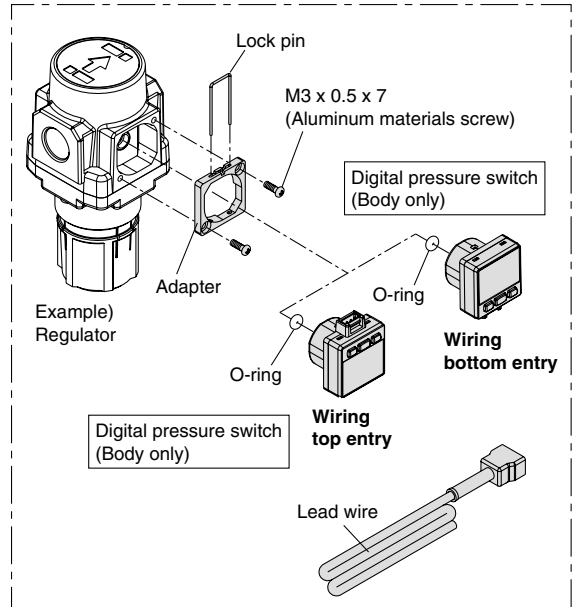

Output Specifications

NPN open collector output

Max. 30 V, 80 mA
Residual voltage 1 V or less

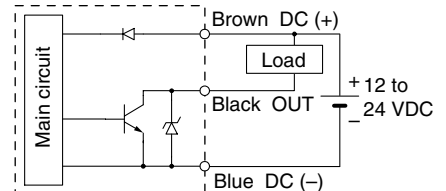

PNP open collector

Max. 80 mA
Residual voltage 1 V or less

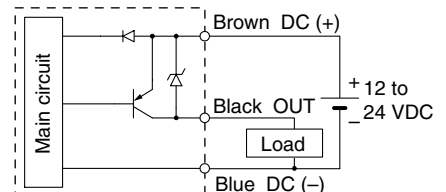





Safety Instructions

These safety instructions are intended to prevent hazardous situations and/or equipment damage. These instructions indicate the level of potential hazard with the labels of “**Caution**,” “**Warning**” or “**Danger**.” They are all important notes for safety and must be followed in addition to International Standards (ISO/IEC), Japan Industrial Standards (JIS)*1) and other safety regulations*2).

- * 1) ISO 4414: Pneumatic fluid power – General rules relating to systems.
ISO 4413: Hydraulic fluid power – General rules relating to systems.
IEC 60204-1: Safety of machinery – Electrical equipment of machines. (Part 1: General requirements)
ISO 10218-1992: Manipulating industrial robots -Safety.
JIS B 8370: General rules for pneumatic equipment.
JIS B 8361: General rules for hydraulic equipment.
JIS B 9960-1: Safety of machinery – Electrical equipment of machines. (Part 1: General requirements)
JIS B 8433-1993: Manipulating industrial robots - Safety.
etc.
- * 2) Labor Safety and Sanitation Law, etc.

 **Caution:** Operator error could result in injury or equipment damage.

 **Warning:** Operator error could result in serious injury or loss of life.

 **Danger :** In extreme conditions, there is a possibility of serious injury or loss of life.

Warning

1. The compatibility of the product is the responsibility of the person who designs the equipment or decides its specifications.

Since the product specified here is used under various operating conditions, its compatibility with specific equipment must be decided by the person who designs the equipment or decides its specifications based on necessary analysis and test results. The expected performance and safety assurance of the equipment will be the responsibility of the person who has determined its compatibility with the product. This person should also continuously review all specifications of the product referring to its latest catalogue information, with a view to giving due consideration to any possibility of equipment failure when configuring the equipment.

2. Only personnel with appropriate training should operate machinery and equipment.

The product specified here may become unsafe if handled incorrectly. The assembly, operation and maintenance of machines or equipment including our products must be performed by an operator who is appropriately trained and experienced.

3. Do not service or attempt to remove product and machinery/equipment until safety is confirmed.

1. The inspection and maintenance of machinery/equipment should only be performed after measures to prevent falling or runaway of the driven objects have been confirmed.

2. When the product is to be removed, confirm that the safety measures as mentioned above are implemented and the power from any appropriate source is cut, and read and understand the specific product precautions of all relevant products carefully.

3. Before machinery/equipment is restarted, take measures to prevent unexpected operation and malfunction.

4. Contact SMC beforehand and take special consideration of safety measures if the product is to be used in any of the following conditions.

1. Conditions and environments outside of the given specifications, or use outdoors or in a place exposed to direct sunlight.

2. Installation on equipment in conjunction with atomic energy, railways, air navigation, space, shipping, vehicles, military, medical treatment, combustion and recreation, or equipment in contact with food and beverages, emergency stop circuits, clutch and brake circuits in press applications, safety equipment or other applications unsuitable for the standard specifications described in the product catalogue.

3. An application which could have negative effects on people, property, or animals requiring special safety analysis.

4. Use in an interlock circuit, which requires the provision of double interlock for possible failure by using a mechanical protective function, and periodical checks to confirm proper operation.



Safety Instructions

Caution

The product is provided for use in manufacturing industries.

The product herein described is basically provided for peaceful use in manufacturing industries.

If considering using the product in other industries, consult SMC beforehand and exchange specifications or a contract if necessary. If anything is unclear, contact your nearest sales branch.

Limited Warranty and Disclaimer/Compliance Requirements

The product used is subject to the following “Limited Warranty and Disclaimer” and “Compliance Requirements”. Read and accept them before using the product.

Limited Warranty and Disclaimer

1. The warranty period of the product is 1 year in service or 1.5 years after the product is delivered.*3)

Also, the product may have specified durability, running distance or replacement parts. Please consult your nearest sales branch.

2. For any failure or damage reported within the warranty period which is clearly our responsibility, a replacement product or necessary parts will be provided.

This limited warranty applies only to our product independently, and not to any other damage incurred due to the failure of the product.

3. Prior to using SMC products, please read and understand the warranty terms and disclaimers noted in the specified catalogue for the particular products.

*** 3) Vacuum pads are excluded from this 1 year warranty.**

A vacuum pad is a consumable part, so it is warranted for a year after it is delivered.

Also, even within the warranty period, the wear of a product due to the use of the vacuum pad or failure due to the deterioration of the rubber material are not covered by the limited warranty.

Compliance Requirements

When the product is exported, strictly follow the laws required by the Ministry of Economy, Trade and Industry (Foreign Exchange and Foreign Trade Control Law).



Series ARP20/30/40

Specific Product Precautions 1

Be sure to read this before handling. Refer to the back of pages 1 and 2 for Safety Instructions and “Precautions for Handling Pneumatic Devices” (M-03-E3A) for Common Precautions.

Design

⚠ Warning

1. Be sure to install a safety device to prevent damage or malfunction of the outlet side components when the output pressure exceeds the set pressure value.
2. Please consult with SMC if the intended application calls for absolutely zero leakage due to special atmospheric requirements, or if the use of a fluid other than air is required.

⚠ Caution

1. Select a model that is suitable for the desired cleanliness by referring to the SMC’s Best Pneumatics catalogue.
2. Components cannot be used for applications that are outside the range of the specifications.
Please consult with SMC when you anticipate using the component outside the range of its specifications (such as temperature and pressure).
3. Even when the product is used in the specified range, it may chatter depending on the operating conditions. Please contact SMC for the details of this chattering.

Selection

⚠ Warning

1. The mineral grease used on internal sliding parts and seals may run down to outlet side components.
Please consult with SMC if this is not desirable.
2. Residual pressure release (outlet pressure release) is not complete by releasing the inlet pressure.
To release residual pressure, select a model with a backflow function. Using a model without a backflow function makes for inconsistent residual pressure release (i.e., residual pressure may or may not be released) depending upon the operating conditions.
3. Please contact SMC if air will not be consumed in the system for a long period of time, or if the outlet side will be used with a sealed circuit and a balanced circuit, as this may cause the set pressure of the outlet side to fluctuate.
4. Set the regulating pressure range for the outlet pressure of the regulator in a range that is 90% or less of the inlet pressure.
If set to above 90%, the outlet pressure will be easily affected by fluctuations in the flow rate and inlet pressure, and become unstable.
5. A safety margin is calculated into the maximum regulating pressure range appearing in the catalogue’s specification table.
However, the outlet pressure may exceed the set pressure due to a delay in the valve’s closing.
6. Please contact SMC when a circuit requires the use of a regulator having relief sensitivity with high precision and setting accuracy.

Mounting

⚠ Caution

1. To avoid reversed connections of the air inlet/outlet, make connections after confirming the “IN/OUT” mark or arrows that indicate the direction of air flow. Reversed connections can cause malfunction.
2. Leave a space of 100 mm or more for maintenance on the valve guide side (opposite side from the knob).
3. When the product is installed between a solenoid valve and an actuator, select a backflow function type.

Adjustment

⚠ Warning

1. Set the regulator while verifying the displayed values of the inlet and outlet pressure gauges.
Turning the knob excessively can cause damage to the internal parts.
2. Do not use a tool on the pressure regulator knob as this can cause damage. It must be operated manually.

⚠ Caution

1. Be sure to check the inlet pressure before setting the outlet pressure.
2. Be sure to unlock the knob before adjusting the pressure and lock it after setting the pressure.
Failure to follow this procedure can cause damage to the knob and the outlet pressure may fluctuate.
 - Pull the pressure regulator knob to unlock. (You can visually verify this with the “orange mark” that appears in the gap.)
 - Push the pressure regulator knob to lock. When the knob is not easily locked, turn it left and right a little and then push it (when the knob is locked, the “orange mark”, i.e., the gap will disappear).

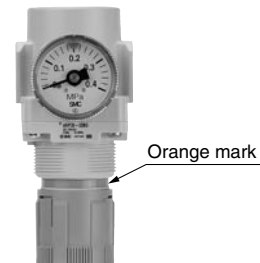

3. To set the pressure using the knob, turn the knob in the direction that increases pressure and lock the knob after the pressure is set.
If this is done in the direction that decreases pressure, the pressure may drop from the original set pressure. Turning the knob clockwise increases the outlet pressure, and turning it counterclockwise reduces the pressure.
4. Do not apply pressure exceeding the range of specifications.
It can damage the pressure gauge.



Series ARP20/30/40

Specific Product Precautions 2

Be sure to read this before handling. Refer to the back of pages 1 and 2 for Safety Instructions and “Precautions for Handling Pneumatic Devices” (M-03-E3A) for Common Precautions.

Adjustment

Caution

- 5. **The product consumes a small amount of fluid from the bleed port.**

The product is designed to have a bleed mechanism for highly accurate pressure adjustment, and consumes a small amount of fluid from the bleed port. This should not be considered abnormal.

Air Supply

Warning

- 1. **Use a mist separator on the inlet side of the product.**
If the supplied air contains condensate or dust, the bleed mechanism can malfunction.
- 2. **Do not use a lubricator on the inlet side of the product, as the bleed mechanism can malfunction.**

Piping

Warning

- 1. **To screw piping materials into components, tighten with a recommended tightening torque while holding the female thread side.**

If the minimum tightening torque is not observed, this can cause a looseness and seal failure. On the other hand, excess tightening torque can cause damage to the threads. Furthermore, tightening without holding the female thread side can cause damage due to the excess force that is applied directly to the piping bracket.

Recommended Tightening Torque

Unit: N·m

Connection thread	1/8	1/4	3/8	1/2
Torque	7 to 9	12 to 14	22 to 24	28 to 30

- 2. **Avoid excessive torsional moment or bending moment other than those caused by the equipment’s own weight as this can cause damage.**
Support external piping separately.
- 3. **Piping materials without flexibility such as steel tube piping are prone to be affected by excess moment load and vibration from the piping side. Use flexible tubing in between to avoid such an effect.**

Maintenance

Warning

- 1. **When disassembly or installation is required during the maintenance, repair, or replacement of a device, be sure to follow the instructions provided in the operation manual or safety instructions in this catalogue.**
- 2. **When using the regulator with a backflow function between a solenoid valve and an actuator, check the pressure gauge periodically.**

Sudden pressure fluctuations may shorten the durability of the pressure gauge. A digital pressure gauge is recommended for such situation or as deemed necessary.

Caution

- 1. **For emergency action in the event of setting failure or leakage from the relief port, refer to “Troubleshooting” in the Operation Manual of the product.**

EUROPEAN SUBSIDIARIES:

Austria

SMC Pneumatik GmbH (Austria).
Girakstrasse 8, A-2100 Korneuburg
Phone: +43 2262-62280, Fax: +43 2262-62285
E-mail: office@smc.at
http://www.smc.at

France

SMC Pneumatique, S.A.
1, Boulevard de Strasbourg, Parc Gustave Eiffel
Bussy Saint Georges F-77607 Marne La Vallée Cedex 3
Phone: +33 (0)1-6476 1000, Fax: +33 (0)1-6476 1010
E-mail: contact@smc-france.fr
http://www.smc-france.fr

Netherlands

SMC Pneumatics BV
De Ruyterkade 120, NL-1011 AB Amsterdam
Phone: +31 (0)20-5318888, Fax: +31 (0)20-5318880
E-mail: info@smcpneumatics.nl
http://www.smcpneumatics.nl

Spain

SMC España, S.A.
Zuazobidea 14, 01015 Vitoria
Phone: +34 945-184 100, Fax: +34 945-184 124
E-mail: post@smc.smces.es
http://www.smc.eu

Belgium

SMC Pneumatics N.V./S.A.
Nijverheidsstraat 20, B-2160 Wommelgem
Phone: +32 (0)3-355-1464, Fax: +32 (0)3-355-1466
E-mail: info@smcpneumatics.be
http://www.smcpneumatics.be

Germany

SMC Pneumatik GmbH
Boschring 13-15, D-63329 Egelsbach
Phone: +49 (0)6103-4020, Fax: +49 (0)6103-402139
E-mail: info@smc-pneumatik.de
http://www.smc-pneumatik.de

Norway

SMC Pneumatics Norway A/S
Vollsveien 13 C, Granfos Næringspark N-1366 Lysaker
Tel: +47 67 12 90 20, Fax: +47 67 12 90 21
E-mail: post@smc-norge.no
http://www.smc-norge.no

Sweden

SMC Pneumatics Sweden AB
Ekhagsvägen 29-31, S-141 71 Huddinge
Phone: +46 (0)8-603 12 00, Fax: +46 (0)8-603 12 90
E-mail: post@smcpneumatics.se
http://www.smc.nu

Bulgaria

SMC Industrial Automation Bulgaria EOOD
Business Park Sofia, Building 8 - 6th floor, BG-1715 Sofia
Phone: +359 2 9744492, Fax: +359 2 9744519
E-mail: office@smc.bg
http://www.smc.bg

Greece

SMC Hellas EPE
Anagenniseos 7-9 - P.C. 14342, N. Philadelphia, Athens
Phone: +30-210-2717265, Fax: +30-210-2717766
E-mail: sales@smchellas.gr
http://www.smchellas.gr

Poland

SMC Industrial Automation Polska Sp.z.o.o.
ul. Poloneza 89, PL-02-826 Warszawa
Phone: +48 22 211 9600, Fax: +48 22 211 9617
E-mail: office@smc.pl
http://www.smc.pl

Switzerland

SMC Pneumatik AG
Dorfstrasse 7, CH-8484 Weisslingen
Phone: +41 (0)52-396-3131, Fax: +41 (0)52-396-3191
E-mail: info@smc.ch
http://www.smc.ch

Croatia

SMC Industrijska automatika d.o.o.
Crnomerec 12, HR-10000 ZAGREB
Phone: +385 1 377 66 74, Fax: +385 1 377 66 74
E-mail: office@smc.hr
http://www.smc.hr

Hungary

SMC Hungary Ipari Automatizálási Kft.
Torbágy út 19, H-2045 Törökbálint
Phone: +36 23 511 390, Fax: +36 23 511 391
E-mail: office@smc.hu
http://www.smc.hu

Portugal

SMC Sucursal Portugal, S.A.
Rua de Eng^o Ferreira Dias 452, 4100-246 Porto
Phone: +351 226 166 570, Fax: +351 226 166 589
E-mail: postpt@smc.smces.es
http://www.smc.eu

Turkey

Entek Pnömatik San. ve Tic. A*.
Perpa Ticaret Merkezi B Blok Kat:11 No: 1625, TR-34386, Okmeydanı, Istanbul
Phone: +90 (0)212-444-0762, Fax: +90 (0)212-221-1519
E-mail: smc@entek.com.tr
http://www.entek.com.tr

Czech Republic

SMC Industrial Automation CZ s.r.o.
Hudcova 78a, CZ-61200 Brno
Phone: +420 5 414 24611, Fax: +420 5 412 18034
E-mail: office@smc.cz
http://www.smc.cz

Ireland

SMC Pneumatics (Ireland) Ltd.
2002 Citywest Business Campus, Naas Road, Saggart, Co. Dublin
Phone: +353 (0)1-403 9000, Fax: +353 (0)1-464-0500
E-mail: sales@smcpneumatics.ie
http://www.smcpneumatics.ie

Romania

SMC Romania srl
Str Frunzei 29, Sector 2, Bucharest
Phone: +40 213205111, Fax: +40 213261489
E-mail: smcromania@smcromania.ro
http://www.smcromania.ro

UK

SMC Pneumatics (UK) Ltd
Vincent Avenue, Crownhill, Milton Keynes, MK8 0AN
Phone: +44 (0)800 1382930 Fax: +44 (0)1908-555064
E-mail: sales@smcpneumatics.co.uk
http://www.smcpneumatics.co.uk

Denmark

SMC Pneumatik A/S
Egeskovvej 1, 8700 Horsens
Phone: +45 70252900, Fax: +45 70252901
E-mail: smc@smcdk.com
http://www.smcdk.com

Italy

SMC Italia S.p.A
Via Garibaldi 62, I-20061 Carugate, (Milano)
Phone: +39 (0)2-92711, Fax: +39 (0)2-9271365
E-mail: mailbox@smcitalia.it
http://www.smcitalia.it

Russia

SMC Pneumatik LLC.
4B Sverdlovskaja nab, St. Petersburg 195009
Phone: +7 812 718 5445, Fax: +7 812 718 5449
E-mail: info@smc-pneumatik.ru
http://www.smc-pneumatik.ru

Estonia

SMC Pneumatics Estonia OÜ
Laki 12, 106 21 Tallinn
Phone: +372 6510370, Fax: +372 65110371
E-mail: smc@smcpneumatics.ee
http://www.smcpneumatics.ee

Latvia

SMC Pneumatics Latvia SIA
Smerla 1-705, Riga LV-1006
Phone: +371 781-77-00, Fax: +371 781-77-01
E-mail: info@smclv.lv
http://www.smclv.lv

Slovakia

SMC Priemyselná Automatizácia, s.r.o.
Fatranská 1223, 01301 Teplicka Nad Váhom
Phone: +421 41 3213212 - 6 Fax: +421 41 3213210
E-mail: office@smc.sk
http://www.smc.sk

Finland

SMC Pneumatics Finland Oy
PL72, Tiistinniityntie 4, SF-02231 ESPOO
Phone: +358 207 513513, Fax: +358 207 513599
E-mail: smcfin@smc.fi
http://www.smc.fi

Lithuania

SMC Pneumatics Lietuva, UAB
Oslo g.1, LT-04123 Vilnius
Phone: +370 5 264 81 26, Fax: +370 5 264 81 26

Slovenia

SMC industrijska Avtomatika d.o.o.
Mirska cesta 7, SI-8210 Trebnje
Phone: +386 7 3885412 Fax: +386 7 3885435
E-mail: office@smc.si
http://www.smc.si

OTHER SUBSIDIARIES WORLDWIDE:

ARGENTINA, AUSTRALIA, BOLIVIA, BRASIL, CANADA, CHILE,
CHINA, HONG KONG, INDIA, INDONESIA, MALAYSIA, MEXICO,
NEW ZEALAND, PHILIPPINES, SINGAPORE, SOUTH KOREA,
TAIWAN, THAILAND, USA, VENEZUELA

<http://www.smc.eu>
<http://www.smcworld.com>