

3-Screen Display

High-Precision Digital Pressure Switch



New

An **IO-Link** compatible type has been added to the 20C series for general fluids. [p. 5](#)



New

A low pressure range type has been added to the 20A series. [p. 6](#)



It is possible to change the settings

Main screen

Measured value (Current pressure value)

while checking the measured value.

Sub screen

Label (Display item), Set value (Threshold value)



Visualization of settings

| | | | | | |
|-----------------------------|------|------------|------|------------------|------|
| Set value (Threshold value) | P.1 | Peak value | H.H. | Hysteresis value | H.L. |
| Bottom value | H.Lo | Delay time | dt1 | | |

| Applicable fluid | Series | Output type | Enclosure | Copy function | Piping | | | |
|------------------|--|--|-----------|---------------|------------------|-----------------------|--|-------------------------------|
| | | | | | M5 female thread | 1/8 (R, NPT) | One-touch fittings (ø4 mm, ø6 mm, ø1/4 inch) | 1/4 (R, NPT, G) (URJ*1/TSJ*2) |
| Air | ZSE20(F)/ISE20 p. 9 | 1 output | IP40 | — | ● | ● | ● | — |
| | ZSE20A(F)/ISE20A p. 11 | 2 outputs Analog output (Voltage/Current) | IP40 | ● | ● | ● | ● | — |
| | ZSE20B(F)-(L)/ISE20B-(L) pp. 13, 15 | 2 outputs Analog output (Voltage/Current) IO-Link/ Switch: 1 output | IP65 | ● —*4 | ● | ● | ●*5 — | — |
| General fluids | ZSE20C(F)-(L)/ISE20C(H)-(L) pp. 25, 27 | 2 outputs Analog output (Voltage/Current) IO-Link/ Switch: 1 output | IP65 | ● —*4 | ●*3 | ● (Rc thread only) | — | ● |

*1 Face seal fitting *2 Compression fitting *3 With 1/4 (R, NPT, G) M5 female threaded

*4 A block parameter or data storage function is provided with the IO-Link compatible type. *5 Only the ø4 mm or ø6 mm elbow type One-touch fitting is applicable.

ZSE20□(F)/ISE20□ Series



CAT.ES100-114E

Improved Operability

Visualization of Settings

The sub screen (label) shows the item to be set.

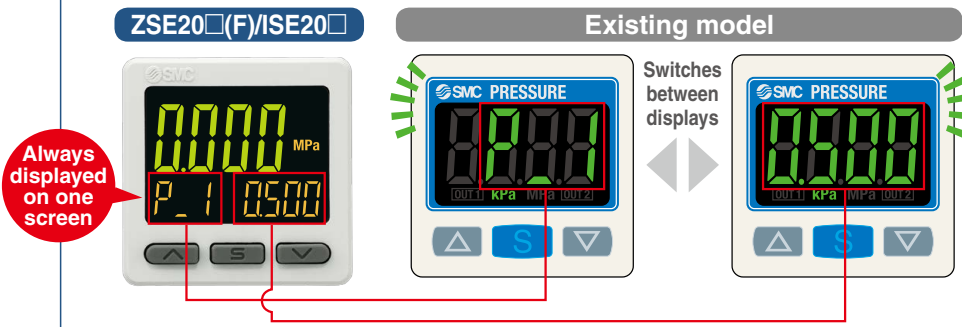

Mode Examples

| Hysteresis mode | | | |
|-----------------|-----------------------------|-----------------|-----------------------------|
| Normal output | Set value (Threshold value) | Reversed output | Set value (Threshold value) |
| P_1 | 0500 | n_1 | 0500 |
| Hysteresis | Set hysteresis value | | |
| H_1 | 0050 | | |

| Window comparator mode | | | |
|-------------------------|-----------------------------|-------------------------|-----------------------------|
| Normal output/Lo side | Set value (Threshold value) | Normal output/Hi side | Set value (Threshold value) |
| P_L | 0300 | P_H | 0500 |
| Reversed output/Lo side | Set value (Threshold value) | Reversed output/Hi side | Set value (Threshold value) |
| n_L | 0300 | n_H | 0500 |

Simple 3-Step Setting

When the S button is pressed and the set value (P_1) is being displayed, the set value (threshold value) can be set. When the S button is pressed and the hysteresis (H_1) is being displayed, the hysteresis value can be set.



Now with a snap shot function for set value reading

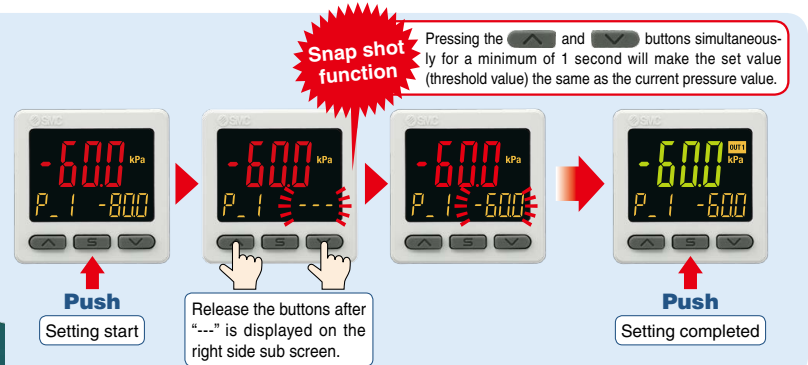
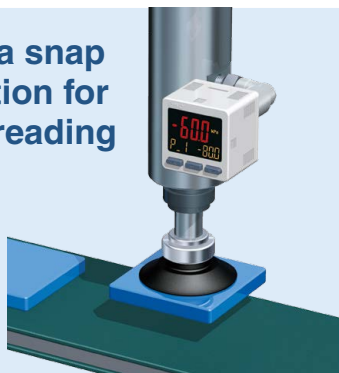

Easy Screen Switching

It is possible to change the settings while checking the measured value.

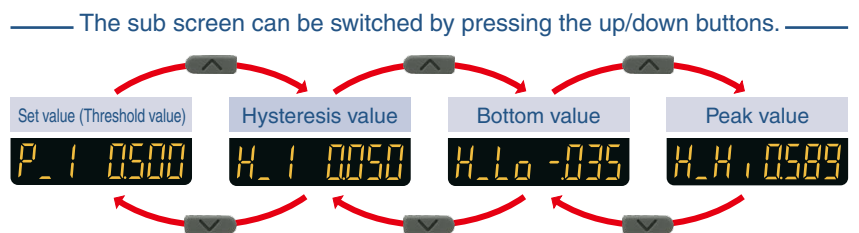
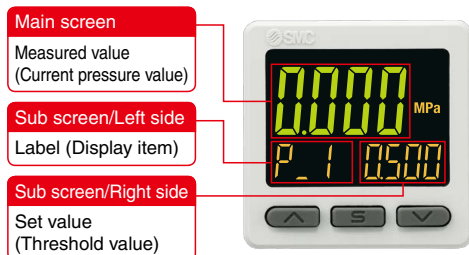

* One additional arbitrary display mode can be added via the function settings. (Refer to page 3.)
 * Example for 1 output

3 Setting Modes Select the setting mode that best meets your needs.

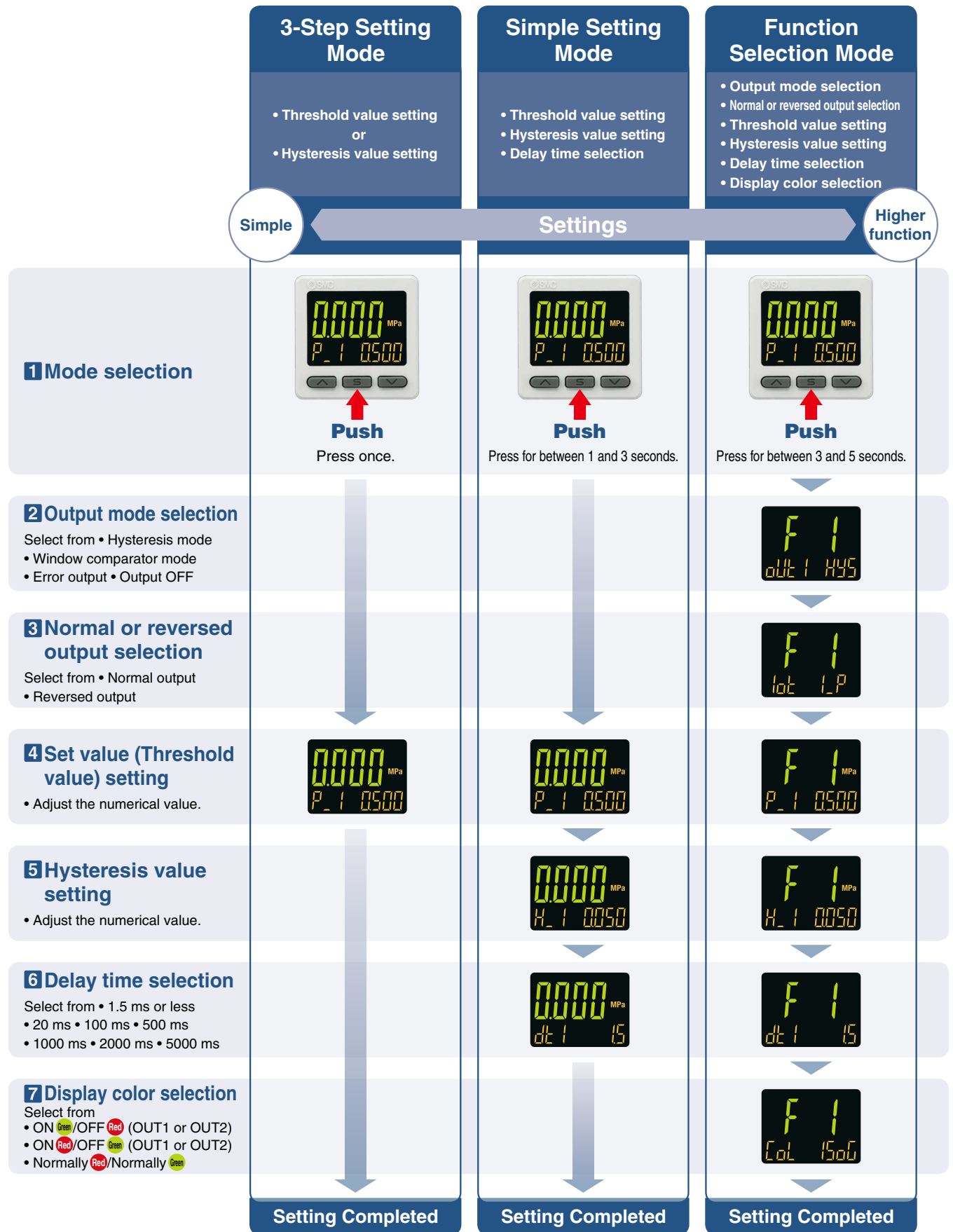

* For 1 output

Improved Operability

Other Sub Screen Display

The peak value or bottom value, or both values can be displayed on one screen!

* Peak and bottom values are maintained even if the power supply is cut.

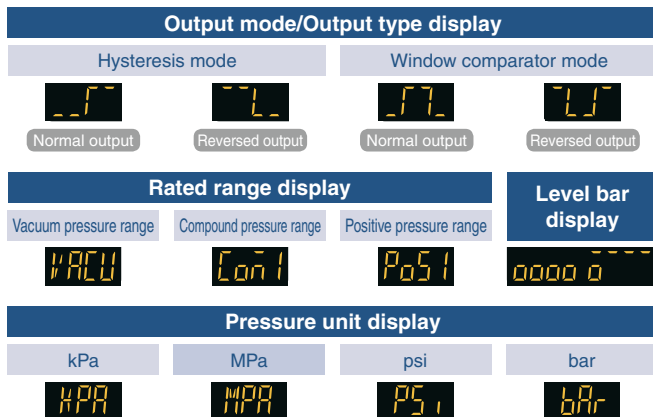
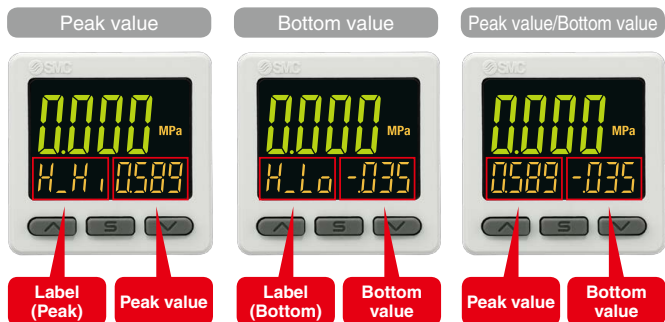

* A combination of the displays shown above and the set values can be displayed on the 2 sub screens.

Delay Time 1.5 ms*1 or less

*1 Select from 1.5 ms or less, 20 ms, 100 ms, 500 ms, 1000 ms, 2000 ms, or 5000 ms.

Convenient Functions

pp. 17, 29

| Functions | Copy function | Auto-shift function | Security code | Power saving mode | Resolution switch function | MPa/kPa switch function |
|-----------|---------------|---------------------|---------------|-------------------|----------------------------|-------------------------|
| 20 | — | — | ● | ● | ● | ● |
| 20A | ● | ● | ● | ● | ● | ● |
| 20B | ● | ● | ● | ● | ● | ● |
| 20B-L | — | — | ● | ● | ● | ● |
| 20C | ● | ● | ● | ● | ● | ● |
| 20C-L | — | — | ● | ● | ● | ● |

● Copy function

The set values of the sensor can be copied.



● Auto-shift function

This measures the pressure at the time of external input and uses it as a reference to correct the on-off point of the switch.

● Security code

The key-lock function keeps unauthorized persons from tampering with the settings.

● Power saving mode

Power consumption is reduced by turning off the monitor.

| Series | Current consumption | Reduction rate*1 |
|---------|---------------------|-----------------------|
| 20 | 25 mA or less | Approx. 60% reduction |
| 20A | 35 mA or less | Approx. 40% reduction |
| 20B(-L) | | |
| 20C(-L) | | |

*1 In power saving mode

● Display resolution switch function

Reduces monitor flickering

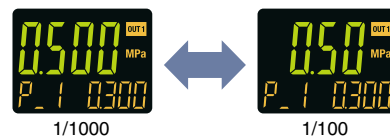

(Only the displayed values are changed; the accuracy remains the same.)

● MPa/kPa switch function

Vacuum, compound, and/or positive pressure can be displayed in MPa or kPa.



Compact & Lightweight

- **Compact: Max. 17.5 mm shorter**
(When an M5 female thread is used.)

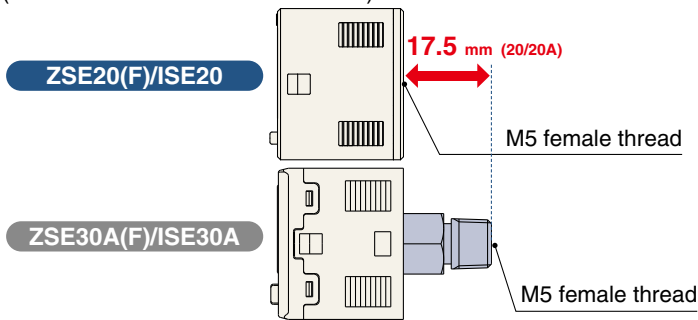

- **Lightweight: Max. 21 g lighter**
(When an M5 female thread is used.)

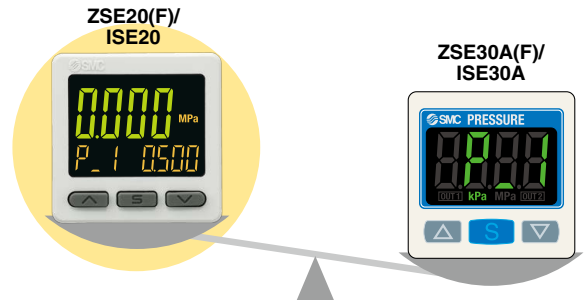

Improved Installability

Connector type

Wiring is possible after piping has been connected.

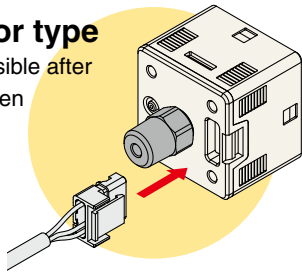

Grommet type
ZSE/ISE40, 80 series



Enclosure

Connector structure

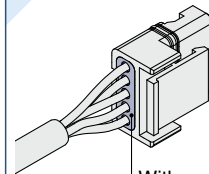

With waterproof cover
(20B, 20C)

Enclosure Ratings

| Series | IP40 | IP65 |
|---------|------|------|
| 20 | ● | — |
| 20A | ● | — |
| 20B(-L) | — | ● |
| 20C(-L) | — | ● |

Mounting

Available Mounting Options

| Series | Bracket A | Bracket B | Bracket C | Panel mount |
|---------|-----------|-----------|-----------|-------------|
| 20 | ● | ● | — | ● |
| 20A | ● | ● | — | ● |
| 20B(-L) | ● | ● | — | ● |
| 20C(-L) | ● | — | ● | ● |

The bracket configuration allows for mounting in four orientations.

Bracket A

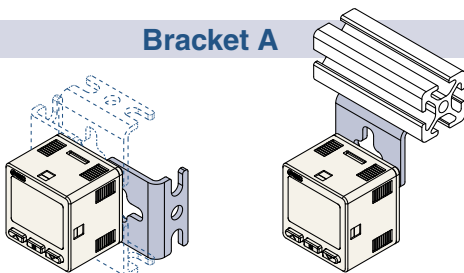

Mounting example

Bracket B

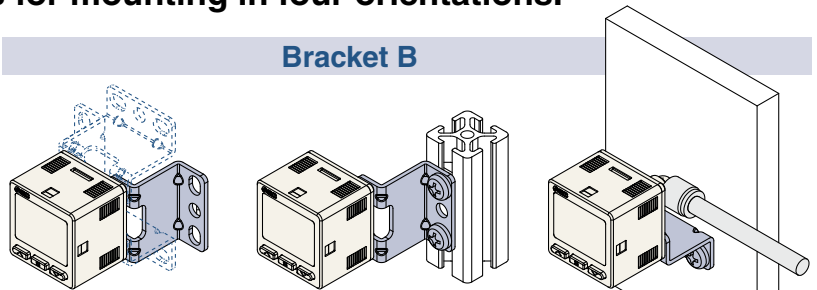

Mounting example

Bracket C

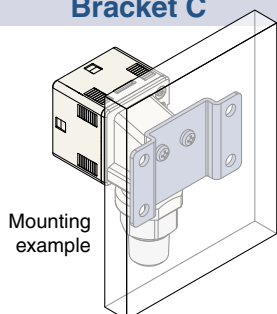

Mounting example

Panel mount

Mountable side by side both vertically and horizontally

One opening!

- Reduced panel fitting labor
- Space saving

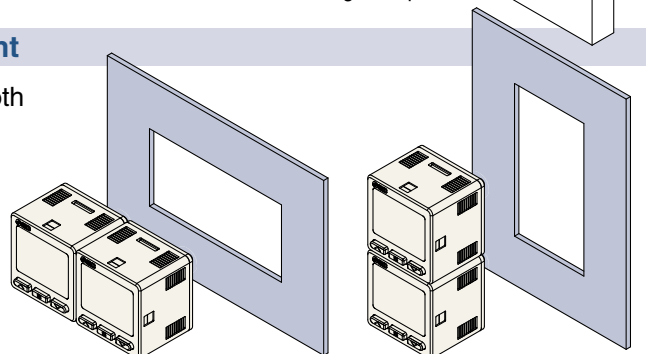

IO-Link Compatible ZSE20B(F)-L/ISE20B-L, ZSE20C(F)-L/ISE20C(H)-L pp. 15, 27

Visualization of operation/equipment status/Remote monitoring and control by communication

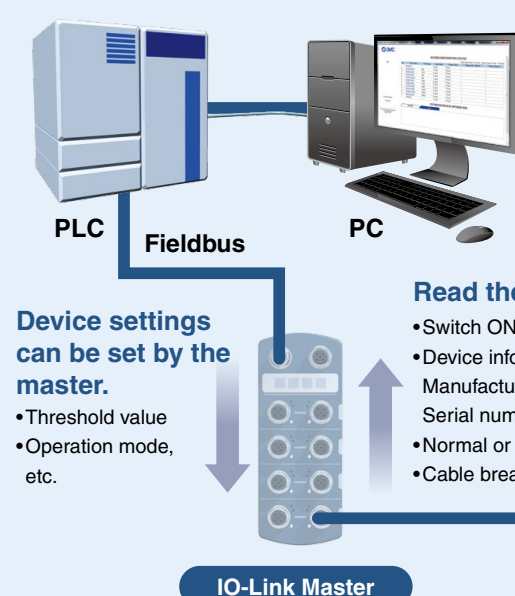

Configuration File (IODD File*1)
 •Manufacturer •Product part no. •Set value

***1 IODD File:**
 IODD is an abbreviation of IO Device Description. This file is necessary for setting the device and connecting it to a master. Save the IODD file on the PC to be used to set the device prior to use.

IO-Link

IO-Link is an open communication interface technology between the sensor/actuator and the I/O terminal that is an international standard: IEC 61131-9.



IO-Link Compatible Device
 ZSE20B(F)-L/ISE20B-L
 ZSE20C(F)-L/ISE20C(H)-L

- Read the device data.**
- Switch ON/OFF signal and analog value
 - Device information: Manufacturer, Product part number, Serial number, etc.
 - Normal or abnormal device status
 - Cable breakage

Implement diagnostic bits in the process data.

The diagnostic bit in the cyclic process data makes it easy to find problems with the equipment. It is possible to find problems with the equipment in real time using the cyclic (periodic) data and to monitor such problems in detail with the noncyclic (aperiodic) data.

Process Data

| Bit offset | Item | Note |
|------------|-------------------------|-----------------------|
| 0 | OUT1 output | 0: OFF 1: ON |
| 1 | OUT2 output | 0: OFF 1: ON |
| 2 | Diagnosis | 0: Normal 1: Abnormal |
| 3 to 15 | Measured pressure value | Unsigned 13 bit |

- Diagnosis items**
- Internal product malfunction
 - Outside of zero-clear range
 - Outside of rated pressure range
 - Upper temperature limit exceeded inside the product

| Bit offset | 15 | 14 | 13 | 12 | 11 | 10 | 9 | 8 | 7 | 6 | 5 | 4 | 3 | 2 | 1 | 0 |
|------------|-------------------------|----|----|----|----|----|---|---|---|---|---|---|---|-----------|------|------|
| Item | Measured pressure value | | | | | | | | | | | | | Diagnosis | OUT2 | OUT1 |

Display function

Displays the output communication status and indicates the presence of communication data

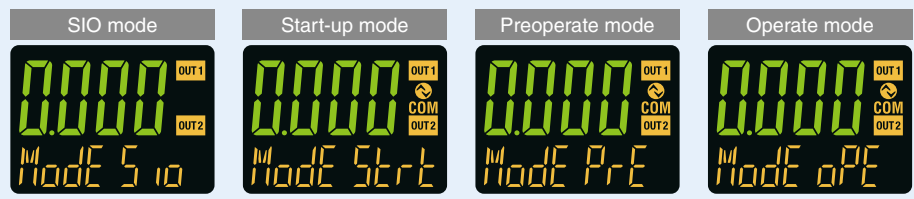

Operation and Display

| Communication with master | IO-Link status indicator light | Status | Screen display*3 | Description | |
|---------------------------|--------------------------------|-----------------------------|--|--|---|
| Yes | COM*1 | IO-Link mode | Operate | Mode oPE | Normal communication status (readout of measured value) At the start of communication |
| | | | Start up | Mode Start | |
| | | | Preoperate | Mode Pr-E | |
| | | Abnormal | Version does not match | Er 15 V 1.0 | The IO-Link version does not match that of the master. The master uses version 1.0. * The applicable IO-Link version is 1.1. |
| Lock | Mode Loc | | Backup and restore required due to data storage lock | | |
| No | OFF | Communication disconnection | Mode oPE | Normal communication was not received for 1 s or longer. | |
| | | | Mode Start | | |
| | | | Mode Pr-E | | |
| | OFF | SIO mode | Mode S io | General switch output | |

*1 The COM indicator is ON when communication with the master is established. *2 In IO-Link mode, the IO-Link indicator will be ON or flashing. *3 When the sub screen is set to Mode



Pressure Switch (for Low Pressure) ZSE20AF-X576 to 580 Made to Order p. 47

Able to detect and display pressures of 10 kPa or less

| Model | -X576 | -X577 | -X578 | -X579 | -X580 |
|----------------------|--------------------|-------------------------|-----------------------|-----------------------|-------------------------|
| Rated pressure range | -500 to 500 Pa | -1.000 to 1.000 kPa | -2.00 to 2.00 kPa | -5.00 to 5.00 kPa | -10.00 to 10.00 kPa |

With zero-cut function

When the pressure display value is close to zero, this function forces the display to zero.
The range within which to display zero can be changed in 0.1% increments as long as it is within 0.0% to 10.0% of the atmospheric pressure and the upper limit of the rated pressure range.

Zero-cut function (When set to 1%)
-500 Pa → ... → -5 → 0 → 5 → ... → 500 Pa

Applications

Flow control

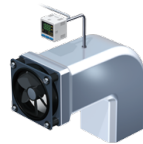

Can control air flow by monitoring the flow rate inside the duct

Liquid level detection

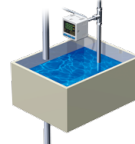

Can detect the liquid level through changes in the purge pressure

Liquid Level Detection Range (for water)

| Pressure range | Liquid level detection range | Min. set value |
|----------------|------------------------------|----------------|
| ±500 Pa | 50 mm | 0.1 mm |
| ±1 kPa | 100 mm | 0.1 mm |
| ±2 kPa | 200 mm | 1 mm |
| ±5 kPa | 500 mm | 1 mm |
| ±10 kPa | 1000 mm | 1 mm |

For General Fluids ZSE20C(F)/ISE20C(H) p. 25



Stainless diaphragm

Oil-free (Single-layer diaphragm structure)

Sensor unit: **Stainless steel 630**

Fitting parts: **Stainless steel 304**

A stainless steel 316L option is also available for the sensor unit and fitting parts.

Enclosure: IP65

Leakage

$1 \times 10^{-10} \text{ Pa}\cdot\text{m}^3/\text{s}$

<Face seal and compression fitting>

$1 \times 10^{-5} \text{ Pa}\cdot\text{m}^3/\text{s}$

<Threaded type (R, Rc, NPT, G)>

Select from 2 piping directions.

Rear ported

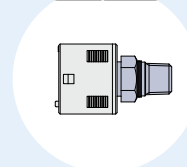

Bottom ported

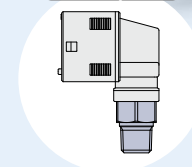

Welded structure for sensor units and fitting parts

Select from a face seal or compression fitting.

Face seal



Compression

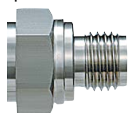

Confirmation of the atmospheric pressure of a load lock chamber

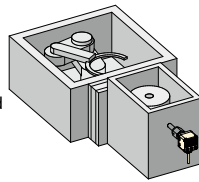

Applicable Fluid Examples

- Water
- Hydraulic fluid (JIS-K2213)
- Silicone oil
- Lubricant
- Fluorocarbon
- Argon
- Carbon dioxide
- Air-containing drainage
- Nitrogen

Made to Order p. 42

- Parts in contact with fluid: Stainless steel 316L (-X500)

This pressure switch has increased corrosion resistance due to the use of stainless steel 316L for the parts in contact with fluid (pressure sensor and fitting).

- Restrictor-installed fitting (-X510)



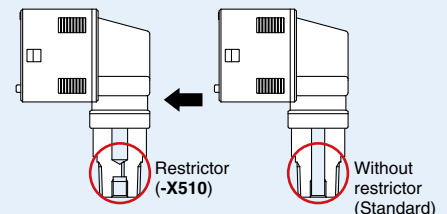

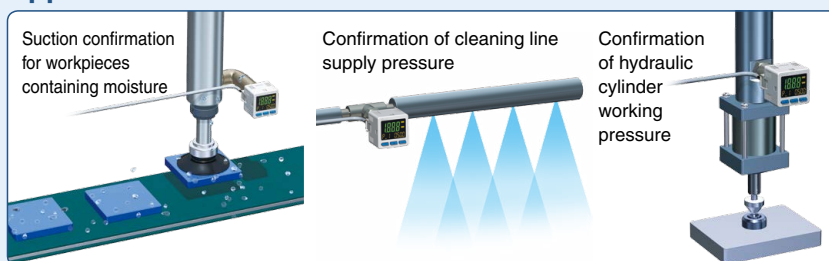

A pressure switch that has a restrictor installed in the fitting is available to prevent the sensor from being damaged by water hammer or fluid inertia.



Applications

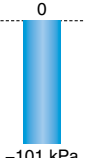
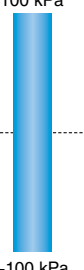
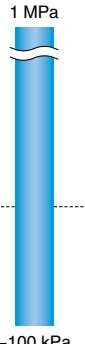
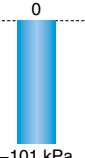
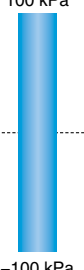
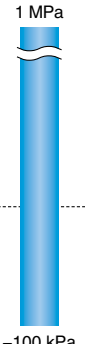

Introduction of Series

| | 1 Output IP40 ZSE20(F)/ISE20 p. 9 | | | 2 Outputs IP40 ZSE20A(F)/ISE20A p. 11 | | |
|-------------------------------|---|---|--|---|--|---|
| Applicable fluid |  Air | | | | | |
| Model | For vacuum pressure  ZSE20 | For compound pressure  ZSE20F | For positive pressure  ISE20 | For vacuum pressure  ZSE20A | For compound pressure  ZSE20AF | For positive pressure  ISE20A |
| Rated pressure range |  |  |  |  |  |  |
| Withstand pressure | 500 kPa | 500 kPa | 1.5 MPa | 500 kPa | 500 kPa | 1.5 MPa |
| Output specification | 1 output (NPN/PNP) | | | 2 outputs (NPN/PNP) | | |
| | | | | Analog (Voltage/Current) | | |
| Enclosure | IP40 | | | IP40 | | |
| Piping | M5 female thread, R1/8, NPT1/8 ø4 mm One-touch fitting ø6 mm One-touch fitting ø1/4 inch One-touch fitting | | | | | |
| Function | — | | | Copy function, Auto-shift function | | |
| Made to order pp. 42 to 48 | Grease-free Lead wire with connector (Terminal cover) Conversion cable for the Z/ISE30A lead wire with connector With spacer for fitting extension | | | Grease-free M12 4-pin pre-wired connector (Lead wire length: 100 mm) Lead wire with connector (Terminal cover) Conversion cable for the Z/ISE30A lead wire with connector With spacer for fitting extension Pressure switch (for low pressure) | | |









CONTENTS

3-Screen Display High-Precision Digital Pressure Switch ZSE20(F)/ISE20 Series

| | |
|---|--------------|
| How to Order | p. 9 |
| Specifications | p. 10 |
| Set Pressure Range and Rated Pressure Range | p. 17 |
| Functions | p. 17 |
| Internal Circuits and Wiring Examples | p. 18 |
| Dimensions | pp. 20 to 23 |

3-Screen Display High-Precision Digital Pressure Switch ZSE20A(F)/ISE20A Series

| | |
|---|--------------|
| How to Order | p. 11 |
| Specifications | p. 12 |
| Set Pressure Range and Rated Pressure Range | p. 17 |
| Analog Output | p. 17 |
| Functions | p. 17 |
| Internal Circuits and Wiring Examples | pp. 18, 19 |
| Dimensions | pp. 20 to 23 |

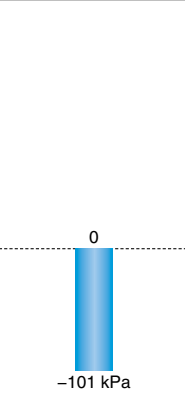
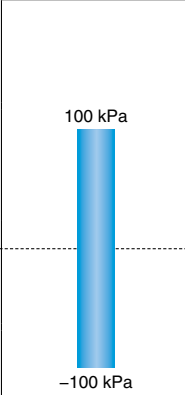
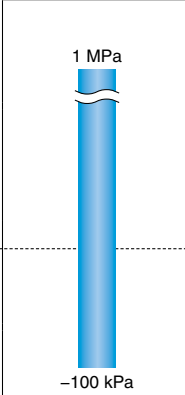
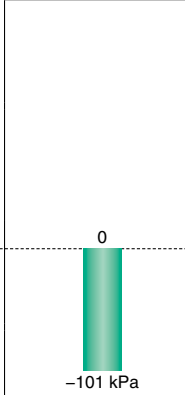
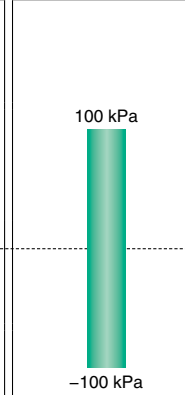
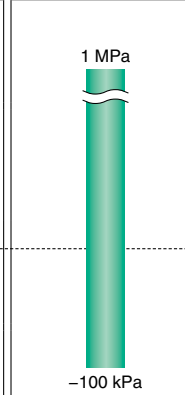
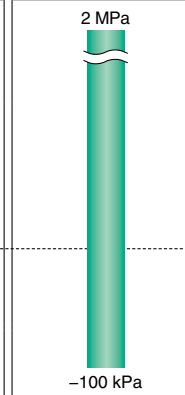
| 2 Outputs IP65 ZSE20B(F)/ISE20B p. 13 | | | 2 Outputs IP65 ZSE20C(F)/ISE20C(H) p. 25 | | | |
|---|--|--|---|---|--|--|
| IO-Link 1 Output IP65 ZSE20B(F)-L/ISE20B-L p. 15 | | | IO-Link 1 Output IP65 ZSE20C(F)-L/ISE20C(H)-L p. 27 | | | |
|  Air | | |  General fluids | | | |
| For vacuum pressure | For compound pressure | For positive pressure | For vacuum pressure | For compound pressure | For positive pressure (1 MPa) | For positive pressure (2 MPa) |
|  |  |  |  |  |  |  |
| ZSE20B(-L) | ZSE20BF(-L) | ISE20B(-L) | ZSE20C(-L) | ZSE20CF(-L) | ISE20C(-L) | ISE20CH(-L) |
|  |  |  |  |  |  |  |
| 500 kPa | 500 kPa | 1.5 MPa | 500 kPa | 500 kPa | 2 MPa | 4 MPa |
| 2 outputs (NPN/PNP)/IO-Link*4 | | | 2 outputs (NPN/PNP)/IO-Link*4 | | | |
| Analog (Voltage/Current)*5 | | | Analog (Voltage/Current) | | | |
| IP65 | | | IP65 | | | |
| M5 female thread, R1/8, NPT1/8 ø4 mm One-touch fitting*5 ø6 mm One-touch fitting*5 | | | R1/4*1, NPT1/4*1, G1/4*1, Rc1/8, URJ1/4*2, TSJ1/4*3 | | | |
| Copy function*5, Auto-shift function*5 | | | Copy function*5, Auto-shift function*5 | | | |
| Grease-free*6 3 m lead wire*6 M8 3-pin pre-wired connector (Lead wire length: 500 mm)*6 M12 4-pin pre-wired connector (Lead wire length: 100 mm)*6 With spacer for fitting extension*6 □36 mm panel hole (Compatible with the panel holes of the Z/ISE40A and Z/ISE80)*6 | | | Parts in contact with fluid: Stainless steel 316L*6 Restrictor-installed fitting*6 3 m lead wire*6 M12 4-pin pre-wired connector (Lead wire length: 100 mm)*6 □36 mm panel hole (Compatible with the panel holes of the Z/ISE40A and Z/ISE80)*6 | | | |

*1 M5 female threaded *2 Face seal fitting *3 Compression fitting *4 1 output in SIO mode (NPN or PNP switching type)
*5 This function is not provided with the IO-Link compatible type. *6 Excludes the IO-Link compatible type (-L)

3-Screen Display High-Precision Digital Pressure Switch ZSE20B(F)/ISE20B Series

How to Order p. 13
Specifications p. 14

3-Screen Display High-Precision Digital Pressure Switch/IO-Link Compatible ZSE20B(F)-L/ISE20B-L Series

How to Order p. 15
Specifications p. 16
Set Pressure Range and Rated Pressure Range p. 17
Analog Output p. 17
IO-Link: Process Data p. 17
Functions p. 17
Internal Circuits and Wiring Examples pp. 18, 19
Dimensions pp. 20 to 23

3-Screen Display High-Precision Digital Pressure Switch for General Fluids ZSE20C(F)/ISE20C(H) Series

How to Order p. 25
Specifications p. 26

3-Screen Display High-Precision Digital Pressure Switch for General Fluids/IO-Link Compatible ZSE20C(F)-L/ISE20C(H)-L Series

How to Order p. 27
Specifications p. 28
Set Pressure Range and Rated Pressure Range p. 29
Analog Output p. 29
IO-Link: Process Data p. 29
Functions p. 29
Internal Circuits and Wiring Examples pp. 30, 31
Dimensions pp. 32 to 37

Function Details pp. 38 to 41
Made to Order pp. 42 to 48
Safety Instructions Back cover

1 Output

3-Screen Display High-Precision Digital Pressure Switch

ZSE20(F)/ISE20 Series



RoHS

IP40

How to Order



Made to Order
(pp. 42 to 48)

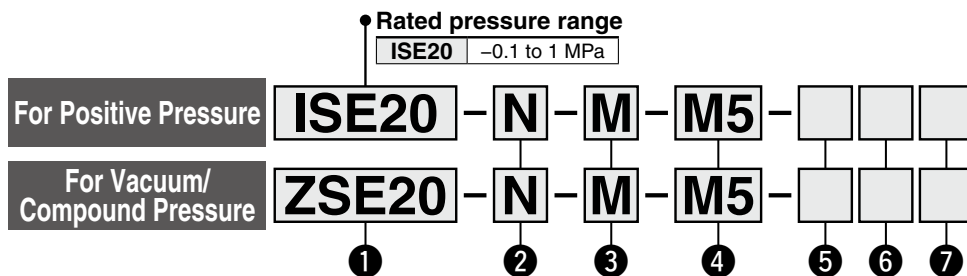

1 Rated pressure range

| | |
|--------|-----------------|
| ZSE20 | 0 to -101 kPa |
| ZSE20F | -100 to 100 kPa |

2 Output specification

| Symbol | Description |
|--------|-----------------------------|
| N | NPN open collector 1 output |
| P | PNP open collector 1 output |

3 Unit specification

| Symbol | Description |
|--------|--|
| Nil | Units selection function*1 |
| M | SI units only*2 |
| P | Units selection function (Initial value psi)*1 |

*1 Under the New Measurement Act, switches with the units selection function are no longer allowed for use in Japan.

*2 Fixed units: kPa, MPa

4 Piping specification

| Symbol | Description | Symbol | Description |
|--------|---|---|---------------------------------------|
| M5 | M5 female thread Piping port | C4H | One-touch fitting ø4 mm Straight type |
| | | C6H | One-touch fitting ø6 mm |
| | | N7H | One-touch fitting ø1/4 inch |
| 01 | R1/8 R1/8 Piping adapter ZS-46-N1 | C4L | One-touch fitting ø4 mm Elbow type |
| | | C6L | One-touch fitting ø6 mm |
| | | N7L | One-touch fitting ø1/4 inch |
| N01 | NPT1/8 NPT1/8 Piping adapter ZS-46-N2 | * One-touch fitting is shipped together with the product. | |

5 Option 1

| Symbol | Description |
|--------|--|
| Nil | Without lead wire |
| L | Lead wire with connector (3-core, 2 m lead wire) |

(Refer to page 22.)

* For the lead wire with M12 connector, refer to page 43.

7 Option 3

| Symbol | Operation manual*1 | Calibration certificate*1 |
|--------|--------------------|---------------------------|
| Nil | ○ | — |
| Y | — | — |
| K | — | — |
| T | — | ○ |

*1 All texts are in both English and Japanese.

6 Option 2

| Symbol | Description |
|--------|---|
| Nil | None |
| A1 | Bracket A (Vertical mounting) ZS-46-A1 |
| A2 | Bracket B (Horizontal mounting) ZS-46-A2 |
| B | Panel mount adapter ZS-46-B |
| D | Panel mount adapter + Front protection cover ZS-46-D |

Options/Part Nos.

When only optional parts are required, order with the part numbers listed below.

| Description | Part no. | Note |
|--|-------------|--|
| Bracket A | ZS-46-A1 | Tapping screw: Nominal size 3 x 8 L (2 pcs.) |
| Bracket B | ZS-46-A2 | Tapping screw: Nominal size 3 x 8 L (2 pcs.) |
| Panel mount adapter | ZS-46-B | — |
| Panel mount adapter + Front protection cover | ZS-46-D | — |
| Lead wire with connector | ZS-46-3L | 3-core, 2 m, Non-waterproof (Without waterproof cover) |
| Lead wire with M12 connector | ZS-46-5LM12 | Made to order (Refer to page 43.) |
| Front protection cover | ZS-27-01 | — |
| R1/8 Piping adapter | ZS-46-N1 | R1/8 NPT1/8 |
| NPT1/8 Piping adapter | ZS-46-N2 | |
| One-touch fitting ø4 mm straight | ZS-46-C4H | — |
| One-touch fitting ø6 mm straight | ZS-46-C6H | — |
| One-touch fitting ø1/4 inch straight | ZS-46-N7H | — |
| One-touch fitting ø4 mm elbow | ZS-46-C4L | — |
| One-touch fitting ø6 mm elbow | ZS-46-C6L | — |
| One-touch fitting ø1/4 inch elbow | ZS-46-N7L | — |
| Spacer for fitting extension | ZS-46-M5A | Made to order (Refer to page 44.) |

3-Screen Display High-Precision Digital Pressure Switch **ZSE20(F)/ISE20 Series**

For pressure switch precautions and specific product precautions, refer to the "Operation Manual" on the SMC website.



Specifications

| Model | | ZSE20 (Vacuum pressure) | ZSE20F (Compound pressure) | ISE20 (Positive pressure) | |
|---|--|--|----------------------------|--|--|
| Applicable fluid | | Air, Non-corrosive gas, Non-flammable gas | | | |
| Pressure | Rated pressure range | 0.0 to -101.0 kPa | -100.0 to 100.0 kPa | -0.100 to 1.000 MPa | |
| | Display/Set pressure range | 10.0 to -105.0 kPa | -105.0 to 105.0 kPa | -0.105 to 1.050 MPa | |
| | Display/Smallest settable increment | 0.1 kPa | | 0.001 MPa | |
| | Withstand pressure | 500 kPa | | 1.5 MPa | |
| Power supply | Power supply voltage | 12 to 24 VDC ±10%, Ripple (p-p) 10% or less | | | |
| | Current consumption | 25 mA or less | | | |
| | Protection | Polarity protection | | | |
| Accuracy | Display accuracy | ±2% F.S. ±1 digit (Ambient temperature of 25 ±3°C) | | | |
| | Repeatability | ±0.2% F.S. ±1 digit | | | |
| | Temperature characteristics | ±2% F.S. (25°C standard) | | | |
| Switch output | Output type | NPN or PNP open collector 1 output | | | |
| | Output mode | Hysteresis mode, Window comparator mode, Error output, Output OFF | | | |
| | Switch operation | Normal output, Reversed output | | | |
| | Max. load current | 80 mA | | | |
| | Max. applied voltage (NPN only) | 28 V | | | |
| | Internal voltage drop (Residual voltage) | 1 V or less (at load current of 80 mA) | | | |
| | Delay time*1 | 1.5 ms or less (with anti-chattering function: 20, 100, 500, 1000, 2000, 5000 ms) | | | |
| | Hysteresis | Hysteresis mode | Variable from 0*2 | | |
| | | Window comparator mode | | | |
| | Short circuit protection | Yes | | | |
| Display | Unit*3 | MPa, kPa, kgf/cm ² , bar, psi, inHg, mmHg | | MPa, kPa, kgf/cm ² , bar, psi | |
| | Display type | LCD | | | |
| | Number of screens | 3-screen display (Main screen, Sub screen x 2) | | | |
| | Display color | 1) Main screen: Red/Green 2) Sub screen: Orange | | | |
| | Number of display digits | 1) Main screen: 4 digits (7 segments) 2) Sub screen: 4 digits (Upper 1 digit 11 segments, 7 segments for other) | | | |
| | Indicator light | Lights up when switch output is turned ON. OUT1: Orange | | | |
| Digital filter*4 | 0, 10, 50, 100, 500, 1000, 5000 ms | | | | |
| Environmental resistance | Enclosure | IP40 | | | |
| | Withstand voltage | 1000 VAC for 1 minute between terminals and housing | | | |
| | Insulation resistance | 50 MΩ or more (500 VDC measured via megohmmeter) between terminals and housing | | | |
| | Operating temperature range | Operating: -5 to 50°C, Stored: -10 to 60°C (No condensation or freezing) | | | |
| Operating humidity range | Operating/Stored: 35 to 85% RH (No condensation) | | | | |
| Standards | UL/CSA (E216656), CE/UKCA marking | | | | |
| Length of lead wire with connector | 2 m | | | | |

*1 Value without digital filter (at 0 ms)

*2 If the applied pressure fluctuates around the set value, the hysteresis must be set to a value greater than the amount of fluctuation, or chattering will occur.

*3 Setting is only possible for models with the units selection function. Only MPa or kPa is available for models without this function.

*4 The response time indicates when the set value is 90% in relation to the step input.

* Products with tiny scratches, marks, or display color or brightness variations which do not affect the performance of the product are verified as conforming products.

Piping Specifications and Weights

| Model | M5 | O1 | N01 | C4H | C6H | N7H | C4L | C6L | N7L | |
|---|--|--|--|------|--------------------------------------|-------|---------------------|-------|-----------|------|
| Port size | M5 x 0.8 | R1/8 | NPT1/8 | — | — | — | — | — | — | |
| | One-touch fitting Straight type | — | — | — | ø4 mm ø5/32 inch | ø6 mm | ø1/4 inch | — | — | |
| | One-touch fitting Elbow type | — | — | — | — | — | ø4 mm ø5/32 inch | ø6 mm | ø1/4 inch | |
| Materials of parts in contact with fluid | Sensor pressure receiving area | Silicon | | | | | | | | |
| | Piping port (Common) | PBT, CB156, Heat-resistant PPS, O-ring: HNBR | | | | | | | | |
| | Piping port | — | C3604 (Electroless nickel plating), Stainless steel 304, NBR | | POM, Stainless steel 304, NBR, C3604 | | | | | |
| Weight | Body | 22 g | 32 g | 34 g | 25 g | 26 g | 27 g | 28 g | 28 g | 34 g |
| | Lead wire with connector | +35 g | | | | | | | | |

Cable Specifications

| | | |
|--------------------------------|------------------------------|-----------------------------|
| Conductor cross section | 0.15 mm ² (AWG26) | |
| Insulator | O.D. | 1.0 mm |
| | Color | Brown, Blue, Black (3-core) |
| Sheath | Finished O.D. | ø3.4 |

"Set Pressure Range and Rated Pressure Range," "Functions" → p. 17

"Internal Circuits and Wiring Examples" → p. 18 "Dimensions" → From p. 20

ZSE20(F)
ISE20

ZSE20A(F)
ISE20A

ZSE20B(F)
ISE20B

ZSE20B(F)-L
ISE20B-L

ZSE20C(F)
ISE20C(H)

ZSE20C(F)-L
ISE20C(H)-L

Function
Details

Made to
Order

2 Outputs + Analog Output (Voltage/Current)



3-Screen Display High-Precision Digital Pressure Switch

RoHS

IP40

ZSE20A(F)/ISE20A Series



How to Order

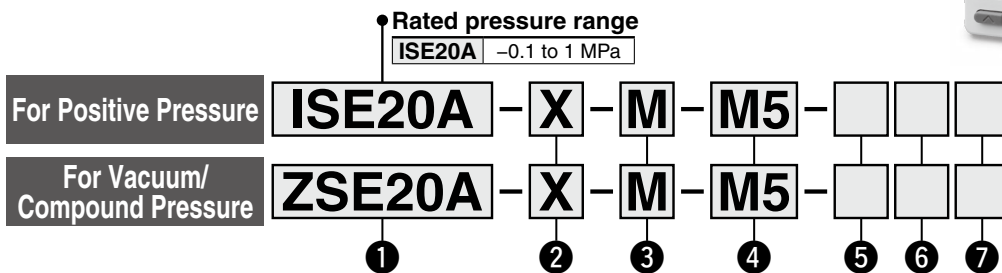

Made to Order (pp. 42 to 48)

① Rated pressure range

| | |
|---------|-----------------|
| ZSE20A | 0 to -101 kPa |
| ZSE20AF | -100 to 100 kPa |

② Output specification

| Symbol | Description |
|--------|---|
| R | NPN open collector 2 outputs + Analog voltage output *1 |
| S | NPN open collector 2 outputs + Analog current output *1 |
| T | PNP open collector 2 outputs + Analog voltage output *1 |
| V | PNP open collector 2 outputs + Analog current output *1 |
| X | NPN open collector 2 outputs + Copy function |
| Y | PNP open collector 2 outputs + Copy function |

*1 Can be switched to auto-shift or copy function

③ Unit specification

| Symbol | Description |
|--------|--|
| Nil | Units selection function*1 |
| M | SI units only*2 |
| P | Units selection function (Initial value psi)*1 |

*1 Under the New Measurement Act, switches with the units selection function are no longer allowed for use in Japan.

*2 Fixed units: kPa, MPa

④ Piping specification

| Symbol | Description | Symbol | Description | |
|--------|---------------------------------------|---|-----------------------------|---------------|
| M5 | M5 female thread Piping port | C4H | One-touch fitting ø4 mm | Straight type |
| | | C6H | One-touch fitting ø6 mm | |
| | | N7H | One-touch fitting ø1/4 inch | |
| 01 | R1/8 R1/8 Piping adapter ZS-46-N1 | C4L | One-touch fitting ø4 mm | Elbow type |
| | | C6L | One-touch fitting ø6 mm | |
| | | N7L | One-touch fitting ø1/4 inch | |
| N01 | NPT1/8 NPT1/8 Piping adapter ZS-46-N2 | * One-touch fitting is shipped together with the product. | | |

⑤ Option 1

| Symbol | Description |
|--------|--|
| Nil | Without lead wire |
| J | Lead wire with connector (5-core, 2 m lead wire) |

* For the lead wire with M12 connector, refer to page 43.

⑦ Option 3

| Symbol | Operation manual*1 | Calibration certificate*1 |
|--------|--------------------|---------------------------|
| Nil | ○ | — |
| Y | — | — |
| K | ○ | ○ |
| T | — | ○ |

*1 All texts are in both English and Japanese.

⑥ Option 2

| Symbol | Description |
|--------|--|
| Nil | None |
| A1 | Bracket A (Vertical mounting) ZS-46-A1 |
| A2 | Bracket B (Horizontal mounting) ZS-46-A2 |
| B | Panel mount adapter ZS-46-B |
| D | Panel mount adapter + Front protection cover ZS-46-D |

Options/Part Nos.

When only optional parts are required, order with the part numbers listed below.

| Description | Part no. | Note |
|--|-------------|--|
| Bracket A | ZS-46-A1 | Tapping screw: Nominal size 3 x 8 L (2 pcs.) |
| Bracket B | ZS-46-A2 | Tapping screw: Nominal size 3 x 8 L (2 pcs.) |
| Panel mount adapter | ZS-46-B | — |
| Panel mount adapter + Front protection cover | ZS-46-D | — |
| Lead wire with connector | ZS-46-5L | 5-core, 2 m, Non-waterproof (Without waterproof cover) |
| Lead wire with M12 connector | ZS-46-5LM12 | Made to order (Refer to page 43.) |
| Front protection cover | ZS-27-01 | — |
| R1/8 Piping adapter | ZS-46-N1 | R1/8 NPT1/8 |
| NPT1/8 Piping adapter | ZS-46-N2 | |
| One-touch fitting ø4 mm straight | ZS-46-C4H | — |
| One-touch fitting ø6 mm straight | ZS-46-C6H | — |
| One-touch fitting ø1/4 inch straight | ZS-46-N7H | — |
| One-touch fitting ø4 mm elbow | ZS-46-C4L | — |
| One-touch fitting ø6 mm elbow | ZS-46-C6L | — |
| One-touch fitting ø1/4 inch elbow | ZS-46-N7L | — |
| Spacer for fitting extension | ZS-46-M5A | Made to order (Refer to page 44.) |

3-Screen Display High-Precision Digital Pressure Switch **ZSE20A(F)/ISE20A Series**

For pressure switch precautions and specific product precautions, refer to the "Operation Manual" on the SMC website.



Specifications

| Model | | ZSE20A (Vacuum pressure) | ZSE20AF (Compound pressure) | ISE20A (Positive pressure) | |
|---|---|--|---|------------------------------|--|
| Applicable fluid | | Air, Non-corrosive gas, Non-flammable gas | | | |
| Pressure | Rated pressure range | 0.0 to -101.0 kPa | -100.0 to 100.0 kPa | -0.100 to 1.000 MPa | |
| | Display/Set pressure range | 10.0 to -105.0 kPa | -105.0 to 105.0 kPa | -0.105 to 1.050 MPa | |
| | Display/Smallest settable increment | 0.1 kPa | | 0.001 MPa | |
| | Withstand pressure | 500 kPa | | 1.5 MPa | |
| Power supply | Power supply voltage | 12 to 24 VDC ±10%, Ripple (p-p) 10% or less | | | |
| | Current consumption | 35 mA or less | | | |
| | Protection | Polarity protection | | | |
| Accuracy | Display accuracy | ±2% F.S. ±1 digit (Ambient temperature of 25 ±3°C) | | | |
| | Repeatability | ±0.2% F.S. ±1 digit | | | |
| | Analog output accuracy | ±2.5% F.S. (Ambient temperature of 25 ±3°C) | | | |
| | Analog output linearity | ±1% F.S. | | | |
| | Temperature characteristics | ±2% F.S. (25°C standard) | | | |
| Switch output | Output type | NPN or PNP open collector 2 outputs | | | |
| | Output mode | Hysteresis mode, Window comparator mode, Error output, Output OFF | | | |
| | Switch operation | Normal output, Reversed output | | | |
| | Max. load current | 80 mA | | | |
| | Max. applied voltage (NPN only) | 28 V | | | |
| | Internal voltage drop (Residual voltage) | 1 V or less (at load current of 80 mA) | | | |
| | Delay time *1 | 1.5 ms or less (with anti-chattering function: 20, 100, 500, 1000, 2000, 5000 ms) | | | |
| | Hysteresis | Hysteresis mode | Variable from 0*2 | | |
| | | Window comparator mode | | | |
| | Short circuit protection | Yes | | | |
| Analog output | Voltage output | Output type | Voltage output: 1 to 5 V | Voltage output: 0.6 to 5 V | |
| | | Output impedance | Approx. 1 kΩ | | |
| | Current output | Output type | Current output: 4 to 20 mA | Current output: 2.4 to 20 mA | |
| | | Load impedance | Maximum load impedance at power supply voltage of 12 V: 300 Ω at power supply voltage of 24 V: 600 Ω Minimum load impedance: 50 Ω | | |
| Auto-shift input | Input type | Non-voltage input: 0.4 V or less | | | |
| | Input mode | Select from Auto-shift or Auto-shift zero. | | | |
| | Input time | 5 ms or more | | | |
| Display | Unit *3 | MPa, kPa, kgf/cm ² , bar, psi, inHg, mmHg | MPa, kPa, kgf/cm ² , bar, psi | | |
| | Display type | LCD | | | |
| | Number of screens | 3-screen display (Main screen, Sub screen x 2) | | | |
| | Display color | 1) Main screen: Red/Green 2) Sub screen: Orange | | | |
| | Number of display digits | 1) Main screen: 4 digits (7 segments) 2) Sub screen: 4 digits (Upper 1 digit 11 segments, 7 segments for other) | | | |
| | Indicator light | Lights up when switch output is turned ON. OUT1, OUT2: Orange | | | |
| Digital filter *4 | 0, 10, 50, 100, 500, 1000, 5000 ms | | | | |
| Environmental resistance | Enclosure | IP40 | | | |
| | Withstand voltage | 1000 VAC for 1 minute between terminals and housing | | | |
| | Insulation resistance | 50 MΩ or more (500 VDC measured via megohmmeter) between terminals and housing | | | |
| | Operating temperature range | Operating: -5 to 50°C, Stored: -10 to 60°C (No condensation or freezing) | | | |
| | Operating humidity range | Operating/Stored: 35 to 85% RH (No condensation) | | | |
| Standards | UL/CSA (E216656), CE/UKCA marking | | | | |
| Length of lead wire with connector | 2 m | | | | |

*1 Value without digital filter (at 0 ms)

*2 If the applied pressure fluctuates around the set value, the hysteresis must be set to a value greater than the amount of fluctuation, or chattering will occur.

*3 Setting is only possible for models with the units selection function. Only MPa or kPa is available for models without this function.

*4 The response time indicates when the set value is 90% in relation to the step input.

* Products with tiny scratches, marks, or display color or brightness variations which do not affect the performance of the product are verified as conforming products.

Piping Specifications and Weights

| Model | M5 | 01 | N01 | C4H | C6H | N7H | C4L | C6L | N7L |
|---|---------------------------------------|---|--------------------------------------|---------------------|-------|-----------|---------------------|-------|-----------|
| Port size | M5 x 0.8 | R1/8 | NPT1/8 | — | — | — | — | — | — |
| One-touch fitting | Straight type | — | — | ∅4 mm ∅5/32 inch | ∅6 mm | ∅1/4 inch | — | — | — |
| | Elbow type | — | — | — | — | — | ∅4 mm ∅5/32 inch | ∅6 mm | ∅1/4 inch |
| Materials of parts in contact with fluid | Sensor pressure receiving area | Silicon | | | | | | | |
| | Piping port (Common) | PBT, CB156, Heat-resistant PPS, O-ring: HNBR | | | | | | | |
| Piping port | — | C3604 (Electroless nickel plating), Stainless steel 304, NBR | POM, Stainless steel 304, NBR, C3604 | | | | | | |
| Weight | Body | 24 g | 34 g | 36 g | 27 g | 28 g | 29 g | 30 g | 36 g |
| | Lead wire with connector | +39 g | | | | | | | |

Cable Specifications

| | | |
|--------------------------------|------------------------------|--|
| Conductor cross section | 0.15 mm ² (AWG26) | |
| Insulator | O.D. | 1.0 mm |
| | Color | Brown, Blue, Black, White, Gray (5-core) |
| Sheath | Finished O.D. | ∅3.5 |

"Set Pressure Range and Rated Pressure Range," "Functions" → p. 17
 "Internal Circuits and Wiring Examples" → From p. 18 "Dimensions" → From p. 20

ZSE20(F)
ISE20

ZSE20A(F)
ISE20A

ZSE20B(F)
ISE20B

ZSE20B(F)-L
ISE20B-L

ZSE20C(F)
ISE20C(H)

ZSE20C(F)-L
ISE20C(H)-L

Function
Details

Made to
Order

2 Outputs + Analog Output (Voltage/Current)



3-Screen Display High-Precision Digital Pressure Switch

RoHS

IP65

ZSE20B(F)/ISE20B Series



For the IO-Link compatible type, refer to page 15.

How to Order

For Positive Pressure

ISE20B - X - M - M5 - [] - [] - []

For Vacuum/Compound Pressure

ZSE20B - X - M - M5 - [] - [] - []



Made to Order (pp. 42 to 48)

1 Rated pressure range

| | |
|---------|-----------------|
| ZSE20B | 0 to -101 kPa |
| ZSE20BF | -100 to 100 kPa |

2 Output specification

| Symbol | Description |
|--------|---|
| R | NPN open collector 2 outputs + Analog voltage output *1 |
| S | NPN open collector 2 outputs + Analog current output *1 |
| T | PNP open collector 2 outputs + Analog voltage output *1 |
| V | PNP open collector 2 outputs + Analog current output *1 |
| X | NPN open collector 2 outputs + Copy function |
| Y | PNP open collector 2 outputs + Copy function |

*1 Can be switched to auto-shift or copy function

3 Unit specification

| Symbol | Description |
|--------|--|
| Nil | Units selection function*1 |
| M | SI units only*2 |
| P | Units selection function (Initial value psi)*1 |

*1 Under the New Measurement Act, switches with the units selection function are no longer allowed for use in Japan.

*2 Fixed units: kPa, MPa

4 Piping specification

| Symbol | Description | Symbol | Description |
|--------|---------------------------------------|---|------------------------------------|
| M5 | M5 female thread Piping port | C4L | One-touch fitting ø4 mm Elbow type |
| | | C6L | One-touch fitting ø6 mm |
| 01 | R1/8 R1/8 Piping adapter ZS-46-N1 | * One-touch fitting is shipped together with the product. | |
| N01 | NPT1/8 NPT1/8 Piping adapter ZS-46-N2 | | |

5 Option 1

| Symbol | Description |
|--------|---|
| Nil | Without lead wire |
| W | Lead wire with connector (5-core, 2 m lead wire, With waterproof cover) |

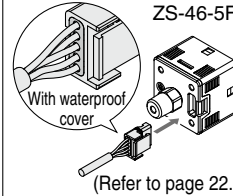

* For the lead wire with M12 connector, refer to page 43.

7 Option 3

| Symbol | Operation manual*1 | Calibration certificate*1 |
|--------|--------------------|---------------------------|
| Nil | ○ | — |
| Y | — | — |
| K | ○ | ○ |
| T | — | ○ |

*1 All texts are in both English and Japanese.

6 Option 2

| Symbol | Description |
|--------|--|
| Nil | None |
| A1 | Bracket A (Vertical mounting) ZS-46-A1 |
| A2 | Bracket B (Horizontal mounting) ZS-46-A2 |
| B | Panel mount adapter ZS-46-B |
| D | Panel mount adapter + Front protection cover ZS-46-D |

Options/Part Nos.

When only optional parts are required, order with the part numbers listed below.

| Description | Part no. | Note |
|--|-------------|---|
| Bracket A | ZS-46-A1 | Tapping screw: Nominal size 3 x 8 L (2 pcs.) |
| Bracket B | ZS-46-A2 | Tapping screw: Nominal size 3 x 8 L (2 pcs.) |
| Panel mount adapter | ZS-46-B | — |
| Panel mount adapter + Front protection cover | ZS-46-D | — |
| Panel mount adapter (Compatible with the panel holes of the Z/ISE40A) | ZS-46-F | Made to order (Refer to page 45.) |
| Panel mount adapter + Front protection cover (Compatible with the panel holes of the Z/ISE40A) | ZS-46-G | Made to order (Refer to page 45.) |
| Lead wire with connector | ZS-46-5F | 5-core, 2 m, Waterproof (With waterproof cover) |
| Lead wire with M12 connector | ZS-46-5FM12 | Made to order (Refer to page 43.) |
| Front protection cover | ZS-27-01 | — |
| R1/8 Piping adapter | ZS-46-N1 | R1/8 NPT1/8 |
| NPT1/8 Piping adapter | ZS-46-N2 | |
| One-touch fitting ø4 mm elbow | ZS-46-C4L | — |
| One-touch fitting ø6 mm elbow | ZS-46-C6L | — |
| Spacer for fitting extension | ZS-46-M5A | Made to order (Refer to page 44.) |

3-Screen Display High-Precision Digital Pressure Switch **ZSE20B(F)/ISE20B Series**

For pressure switch precautions and specific product precautions, refer to the "Operation Manual" on the SMC website.



Specifications

| Model | | ZSE20B (Vacuum pressure) | ZSE20BF (Compound pressure) | ISE20B (Positive pressure) | |
|---|--|--|---|------------------------------|--|
| Applicable fluid | | Air, Non-corrosive gas, Non-flammable gas | | | |
| Pressure | Rated pressure range | 0.0 to -101.0 kPa | -100.0 to 100.0 kPa | -0.100 to 1.000 MPa | |
| | Display/Set pressure range | 10.0 to -105.0 kPa | -105.0 to 105.0 kPa | -0.105 to 1.050 MPa | |
| | Display/Smallest settable increment | 0.1 kPa | | 0.001 MPa | |
| | Withstand pressure | 500 kPa | | 1.5 MPa | |
| Power supply | Power supply voltage | 12 to 24 VDC ±10%, Ripple (p-p) 10% or less | | | |
| | Current consumption | 35 mA or less | | | |
| | Protection | Polarity protection | | | |
| Accuracy | Display accuracy | ±2% F.S. ±1 digit (Ambient temperature of 25 ±3°C) | | | |
| | Repeatability | ±0.2% F.S. ±1 digit | | | |
| | Analog output accuracy | ±2.5% F.S. (Ambient temperature of 25 ±3°C) | | | |
| | Analog output linearity | ±1% F.S. | | | |
| | Temperature characteristics | ±2% F.S. (25°C standard) | | | |
| Switch output | Output type | NPN or PNP open collector 2 outputs | | | |
| | Output mode | Hysteresis mode, Window comparator mode, Error output, Output OFF | | | |
| | Switch operation | Normal output, Reversed output | | | |
| | Max. load current | 80 mA | | | |
| | Max. applied voltage (NPN only) | 28 V | | | |
| | Internal voltage drop (Residual voltage) | 1 V or less (at load current of 80 mA) | | | |
| | Delay time*1 | 1.5 ms or less (with anti-chattering function: 20, 100, 500, 1000, 2000, 5000 ms) | | | |
| | Hysteresis | Hysteresis mode | Variable from 0*2 | | |
| | | Window comparator mode | | | |
| | Short circuit protection | Yes | | | |
| Analog output | Voltage output | Output type | Voltage output: 1 to 5 V | Voltage output: 0.6 to 5 V | |
| | | Output impedance | Approx. 1 kΩ | | |
| | Current output | Output type | Current output: 4 to 20 mA | Current output: 2.4 to 20 mA | |
| | | Load impedance | Maximum load impedance at power supply voltage of 12 V: 300 Ω at power supply voltage of 24 V: 600 Ω Minimum load impedance: 50 Ω | | |
| Auto-shift input | Input type | Non-voltage input: 0.4 V or less | | | |
| | Input mode | Select from Auto-shift or Auto-shift zero. | | | |
| | Input time | 5 ms or more | | | |
| Display | Unit*3 | MPa, kPa, kgf/cm ² , bar, psi, inHg, mmHg | MPa, kPa, kgf/cm ² , bar, psi | | |
| | Display type | LCD | | | |
| | Number of screens | 3-screen display (Main screen, Sub screen x 2) | | | |
| | Display color | 1) Main screen: Red/Green 2) Sub screen: Orange | | | |
| | Number of display digits | 1) Main screen: 4 digits (7 segments) 2) Sub screen: 4 digits (Upper 1 digit 11 segments, 7 segments for other) | | | |
| | Indicator light | Lights up when switch output is turned ON. OUT1, OUT2: Orange | | | |
| Digital filter*4 | 0, 10, 50, 100, 500, 1000, 5000 ms | | | | |
| Environmental resistance | Enclosure | IP65 | | | |
| | Withstand voltage | 1000 VAC for 1 minute between terminals and housing | | | |
| | Insulation resistance | 50 MΩ or more (500 VDC measured via megohmmeter) between terminals and housing | | | |
| | Operating temperature range | Operating: -5 to 50°C, Stored: -10 to 60°C (No condensation or freezing) | | | |
| Operating humidity range | Operating/Stored: 35 to 85% RH (No condensation) | | | | |
| Standards | UL/CSA (E216656), CE/UKCA marking | | | | |
| Length of lead wire with connector | 2 m | | | | |

*1 Value without digital filter (at 0 ms)

*2 If the applied pressure fluctuates around the set value, the hysteresis must be set to a value greater than the amount of fluctuation, or chattering will occur.

*3 Setting is only possible for models with the units selection function. Only MPa or kPa is available for models without this function.

*4 The response time indicates when the set value is 90% in relation to the step input.

* Products with tiny scratches, marks, or display color or brightness variations which do not affect the performance of the product are verified as conforming products.

Piping Specifications and Weights

| Model | M5 | 01 | N01 | C4L | C6L |
|---|---------------------------------------|--|--|--------------------------------------|-------|
| Port size | M5 x 0.8 | R1/8 | NPT1/8 | — | — |
| One-touch fitting | Straight type | — | — | — | — |
| | Elbow type | — | — | ø4 mm ø5/32 inch | ø6 mm |
| Materials of parts in contact with fluid | Sensor pressure receiving area | Silicon | | | |
| | Piping port (Common) | PBT, CB156, Heat-resistant PPS, O-ring: HNBR | | | |
| | Piping port | — | C3604 (Electroless nickel plating), Stainless steel 304, NBR | POM, Stainless steel 304, NBR, C3604 | — |
| Weight | Body | 24 g | 34 g | 36 g | 30 g |
| | Lead wire with connector | +39 g | | | |

Cable Specifications

| | | |
|--------------------------------|------------------------------|--|
| Conductor cross section | 0.15 mm ² (AWG26) | |
| Insulator | O.D. | 1.0 mm |
| | Color | Brown, Blue, Black, White, Gray (5-core) |
| Sheath | Finished O.D. | ø3.5 |

"Set Pressure Range and Rated Pressure Range,"
"Functions" → p. 17
"Internal Circuits and Wiring Examples" → From
p. 18 "Dimensions" → From p. 20

ZSE20(F)
ISE20

ZSE20A(F)
ISE20A

ZSE20B(F)
ISE20B

ZSE20B(F)-L
ISE20B-L

ZSE20C(F)
ISE20C(H)

ZSE20C(F)-L
ISE20C(H)-L

Function
Details

Made to
Order

IO-Link Compatible (1 Output)



3-Screen Display High-Precision Digital Pressure Switch

ZSE20B(F)-L/ISE20B-L Series



For 2 outputs + analog output type, refer to page 13.

How to Order

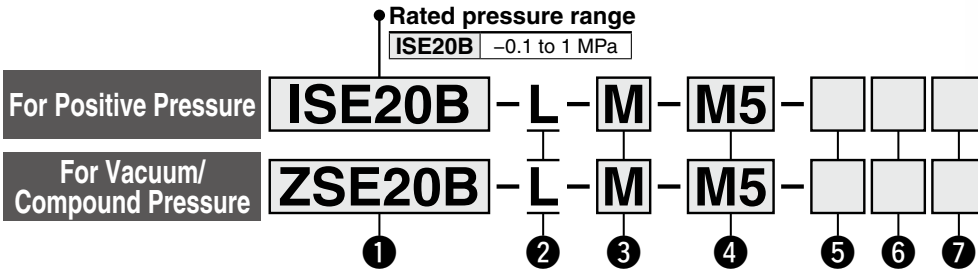

① Rated pressure range

| | |
|---------|-----------------|
| ZSE20B | 0 to -101 kPa |
| ZSE20BF | -100 to 100 kPa |

② Output specification

| Symbol | Description |
|--------|---|
| L | IO-Link/Switch: 1 output ← (PNP or NPN switching type for switch output) |

③ Unit specification

| Symbol | Description |
|--------|--|
| Nil | Units selection function*1 |
| M | SI units only*2 |
| P | Units selection function (Initial value psi)*1 |

*1 Under the New Measurement Act, switches with the units selection function are no longer allowed for use in Japan.

*2 Fixed units: kPa, MPa

④ Piping specification

| Symbol | Description |
|--------|--|
| M5 | M5 female thread |
| 01 | R1/8 R1/8 Piping adapter ZS-46-N1 |
| N01 | NPT1/8 NPT1/8 Piping adapter ZS-46-N2 |

⑤ Option 1

| Symbol | Description |
|--------|---|
| Nil | Without lead wire |
| W | Lead wire with connector (5-core, 2 m lead wire, With waterproof cover) |

* For the lead wire with M12 connector, refer to page 43.

⑦ Option 3

| Symbol | Operation manual*1 | Calibration certificate*1 |
|--------|--------------------|---------------------------|
| Nil | ○ | — |
| Y | — | — |
| K | ○ | ○ |
| T | — | ○ |

*1 All texts are in both English and Japanese.

⑥ Option 2

| Symbol | Description |
|--------|--|
| Nil | None |
| A1 | Bracket A (Vertical mounting) |
| A2 | Bracket B (Horizontal mounting) |
| B | Panel mount adapter |
| D | Panel mount adapter + Front protection cover |

Options/Part Nos.

When only optional parts are required, order with the part numbers listed below.

| Description | Part no. | Note |
|--|-------------|---|
| Bracket A | ZS-46-A1 | Tapping screw: Nominal size 3 x 8 L (2 pcs.) |
| Bracket B | ZS-46-A2 | Tapping screw: Nominal size 3 x 8 L (2 pcs.) |
| Panel mount adapter | ZS-46-B | — |
| Panel mount adapter + Front protection cover | ZS-46-D | — |
| Lead wire with connector | ZS-46-5F | 5-core, 2 m, Waterproof (With waterproof cover) |
| Lead wire with M12 connector | ZS-46-5FM12 | Made to order (Refer to page 43.) |
| Front protection cover | ZS-27-01 | — |
| R1/8 Piping adapter | ZS-46-N1 | R1/8 NPT1/8 |
| NPT1/8 Piping adapter | ZS-46-N2 | |

3-Screen Display High-Precision Digital Pressure Switch **ZSE20B(F)-L/ISE20B-L Series**

For pressure switch precautions and specific product precautions, refer to the "Operation Manual" on the SMC website.



Specifications/IO-Link Compatible

| Model | | ZSE20B-L (Vacuum pressure) | ZSE20BF-L (Compound pressure) | ISE20B-L (Positive pressure) |
|---|---|--|-------------------------------|--|
| Applicable fluid | | Air, Non-corrosive gas, Non-flammable gas | | |
| Pressure | Rated pressure range | 0.0 to -101.0 kPa | -100.0 to 100.0 kPa | -0.100 to 1.000 MPa |
| | Display/Set pressure range | 10.0 to -105.0 kPa | -105.0 to 105.0 kPa | -0.105 to 1.050 MPa |
| | Display/Smallest settable increment | 0.1 kPa | | 0.001 MPa |
| | Withstand pressure | 500 kPa | | 1.5 MPa |
| Power supply | Power supply voltage | 12 to 24 VDC ±10% with 10% voltage ripple or less | | |
| | | When used as a switch output device (When not used as an IO-Link device) | | |
| | | When used as an IO-Link device | | |
| | Current consumption | 35 mA or less | | |
| | Protection | Polarity protection | | |
| Accuracy | Display accuracy | ±2% F.S. ±1 digit (Ambient temperature of 25 ±3°C) | | |
| | Repeatability | ±0.2% F.S. ±1 digit | | |
| | Temperature characteristics | ±2% F.S. (25°C standard) | | |
| Switch output (SIO mode) | Output type | Select from NPN or PNP open collector output. | | |
| | Output mode | Hysteresis, Window comparator, Error output, Output OFF | | |
| | Switch operation | Normal output, Reversed output | | |
| | Max. load current | 80 mA | | |
| | Max. applied voltage | 30 V (NPN output) | | |
| | Internal voltage drop (Residual voltage) | 1.5 V or less (at load current of 80 mA) | | |
| | Delay time*1 | 1.5 ms or less, variable from 0 to 60 s/0.01 s increments | | |
| | Hysteresis | Variable from 0*2 | | |
| | | Window comparator mode | | |
| | | Short circuit protection | Yes | |
| Display | Unit*3 | MPa, kPa, kgf/cm ² , bar, psi, inHg, mmHg | | MPa, kPa, kgf/cm ² , bar, psi |
| | Display type | LCD | | |
| | Number of screens | 3-screen display (Main screen, Sub screen x 2) | | |
| | Display color | Main screen: Red/Green, Sub screen: Orange | | |
| | Number of display digits | Main screen: 4 digits (7 segments), Sub screen: 4 digits (Upper 1 digit 11 segments, 7 segments for other) | | |
| | Indicator light | Lights up when switch output is turned ON (OUT1, OUT2: Orange) | | |
| Digital filter*4 | | Variable from 0 to 30 s/0.01 s increments | | |
| Length of lead wire with connector | | 2 m | | |
| Environmental resistance | Enclosure | IP65 | | |
| | Withstand voltage | 1000 VAC for 1 minute between terminals and housing | | |
| | Insulation resistance | 50 MΩ or more (500 VDC measured via megohmmeter) between terminals and housing | | |
| | Operating temperature range | Operating: -5 to 50°C, Stored: -10 to 60°C (No condensation or freezing) | | |
| | Operating humidity range | Operating/Stored: 35 to 85% RH (No condensation) | | |
| Standards | | CE/UKCA marking | | |
| Communication (IO-Link mode) | IO-Link type | Device | | |
| | IO-Link version | V1.1 | | |
| | Communication speed | COM2 (38.4 kbps) | | |
| | Configuration file | IODD file*5 | | |
| | Minimum cycle time | 2.3 ms | | |
| | Process data length | Input data: 2 bytes, Output data: 0 bytes | | |
| | On request data communication | Yes | | |
| | Data storage function | Yes | | |
| | Event function | Yes | | |
| | Vendor ID | 131 (0 x 0083) | | |

*1 Value without digital filter (at 0 ms)

*2 If the applied pressure fluctuates around the set value, the hysteresis must be set to a value greater than the amount of fluctuation, or chattering will occur.

*3 Setting is only possible for models with the units selection function. Only MPa or kPa is available for models without this function.

*4 The response time indicates when the set value is 90% in relation to the step input.

*5 The configuration file can be downloaded from the SMC website, <https://www.smcworld.com>

* Products with tiny scratches, marks, or display color or brightness variations which do not affect the performance of the product are verified as conforming products.

Piping Specifications and Weights

| Model | | M5 | 01 | N01 |
|---|---------------------------------------|--|--|--------|
| Port size | | M5 x 0.8 | R1/8 | NPT1/8 |
| Materials of parts in contact with fluid | Sensor pressure receiving area | Silicon | | |
| | Piping port (Common) | PBT, CB156, Heat-resistant PPS, O-ring: HNBR | | |
| | Piping port | — | C3604 (Electroless nickel plating), Stainless steel 304, NBR | |
| Weight | Body | 24 g | 34 g | 36 g |
| | Lead wire with connector | +39 g | | |

Cable Specifications

| | | |
|--------------------------------|----------------------|--|
| Conductor cross section | | 0.15 mm ² (AWG26) |
| Insulator | O.D. | 1.0 mm |
| | Color | Brown, Blue, Black, White, Gray (5-core) |
| Sheath | Finished O.D. | ø3.5 |

"Set Pressure Range and Rated Pressure Range," "Functions" → p. 17
 "Internal Circuits and Wiring Examples" → p. 19 "Dimensions" → From p. 20

ZSE20(F)
ISE20

ZSE20A(F)
ISE20A

ZSE20B(F)
ISE20B

ZSE20B(F)-L
ISE20B-L

ZSE20C(F)
ISE20C(H)

ZSE20C(F)-L
ISE20C(H)-L

Function Details

Made to Order

ZSE20□(F)/ISE20□ Series

Set Pressure Range and Rated Pressure Range

Set the pressure within the rated pressure range.

The set pressure range is the range of pressure within which setting is possible. The rated pressure range is the range of pressure that satisfies the specifications (accuracy, linearity, etc.) of the switch. Although it is possible to set a value outside the rated pressure range, the specifications cannot be guaranteed even if the value stays within the set pressure range.

| Switch | Pressure range | | | | |
|--|----------------|---|---------|---------|----------|
| | -100 kPa | 0 | 100 kPa | 500 kPa | 1 MPa |
| For vacuum pressure ZSE20 ZSE20A ZSE20B ZSE20B-L | -101 kPa | 0 | 10 kPa | | |
| For compound pressure ZSE20F ZSE20AF ZSE20BF ZSE20BF-L | -100 kPa | | 100 kPa | | |
| For positive pressure ISE20 ISE20A ISE20B ISE20B-L | -100 kPa | | | | 1 MPa |
| | -105 kPa | | | | 1.05 MPa |
| | (-0.105 MPa) | | | | |

Rated pressure range of the switch
 Set pressure range of the switch

Analog Output^{*1}

Voltage output

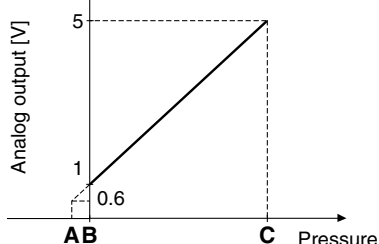

Current output

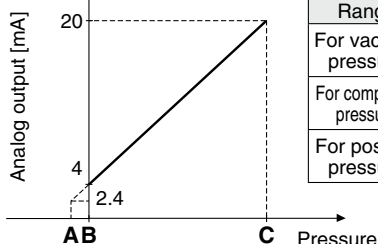

| Range | Rated pressure range | A | B | C |
|-----------------------|----------------------|------------|------------|------------|
| For vacuum pressure | 0.0 to -101.0 kPa | 10.1 kPa | 0 | -101.0 kPa |
| For compound pressure | -100.0 to 100.0 kPa | — | -100.0 kPa | 100.0 kPa |
| For positive pressure | -0.100 to 1.000 MPa | -0.100 MPa | 0 | 1.000 MPa |

*1 Excluding the 20/20B(F)-L

IO-Link: Process Data

Relationship between the process data and pressure value

ZSE20B-L (For vacuum pressure)

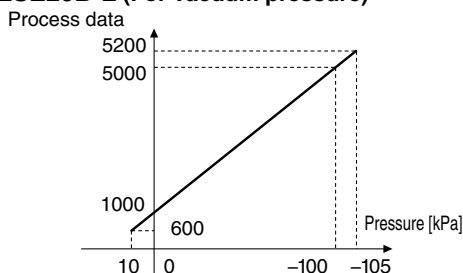

ZSE20BF-L (For compound pressure)

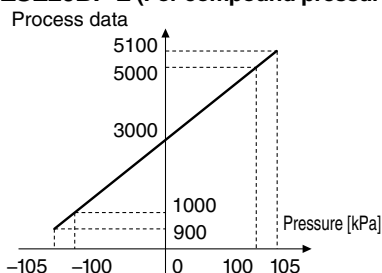

ISE20B-L (For positive pressure)

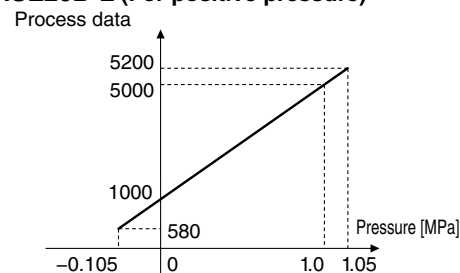

Functions

| | |
|--|---|
| Sub screen setting function | The display of the sub screen can be selected. |
| Auto-preset function | This function calculates a rough set value automatically based on the on-going operation. |
| Display value fine adjustment function | Evens out deviations in the displayed value |
| Peak value indication function | Can retain the maximum pressure value displayed during measurement |
| Bottom value indication function | Can retain the minimum pressure value displayed during measurement |
| Key-lock function (Selectable security code) | The keyboard can be locked to prevent the accidental operation of the operation switch. |
| Zero-clear function | The pressure display can be set to zero when the pressure is open to the atmosphere. |
| Error indication function | This function displays the error location and content when a problem or error has occurred. |
| Anti-chattering function | Prevents possible malfunctions due to sudden fluctuations in the primary pressure by adjusting the delay time |
| Units selection function | Can convert the display value |
| Power saving mode | Reduces power consumption |
| Display resolution switch function | Converts the display resolution from the normal value of 1/1000 to 1/100 Can reduce flickering of the monitor |
| kPa ↔ MPa switch function | Converts the unit between kPa and MPa |
| Copy function ^{*1} | The settings of the copy source can be copied to the copy destination. |
| Auto-shift function ^{*1} | Measures the pressure at the time of external input and uses it as a reference to correct the set value of the switch |

*1 Not available for the 20/20B-L

Internal Circuits and Wiring Examples

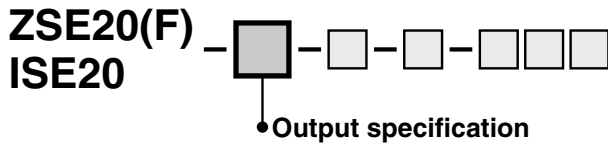

-N
NPN (1 output)

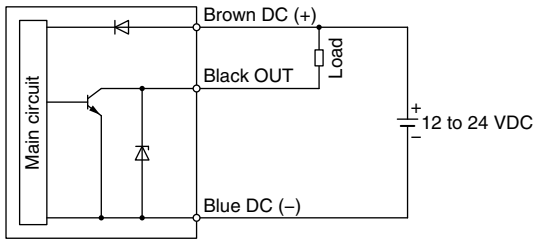

-P
PNP (1 output)

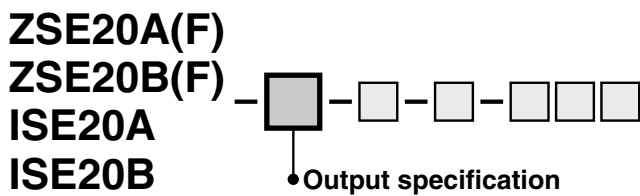
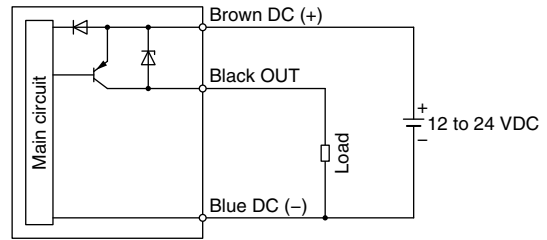

-X
NPN (2 outputs) + Copy function

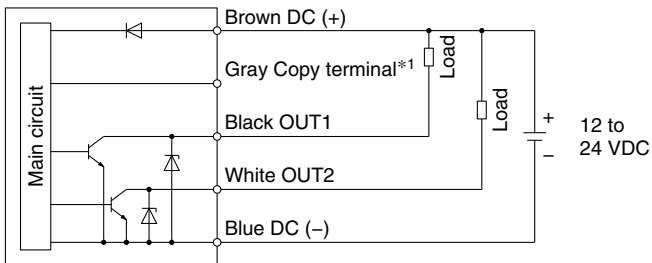

-Y
PNP (2 outputs) + Copy function

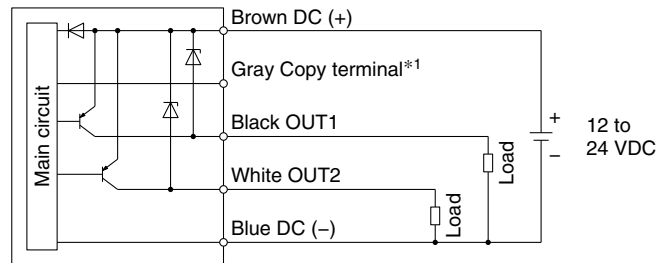

-R: NPN (2 outputs) + Analog voltage output
-S: NPN (2 outputs) + Analog current output

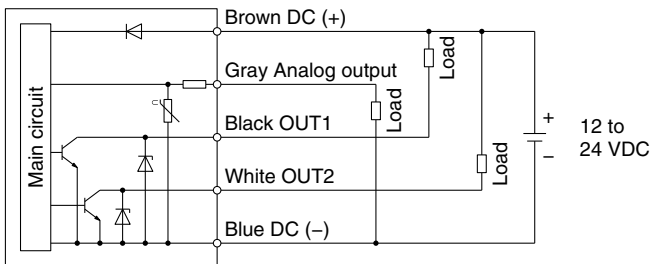

-T: PNP (2 outputs) + Analog voltage output
-V: PNP (2 outputs) + Analog current output

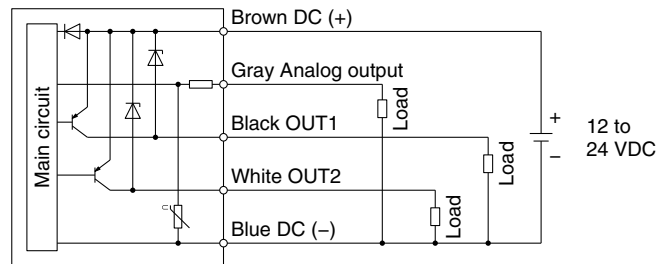

*1 Refer to page 41.

ZSE20(F)
ISE20

ZSE20A(F)
ISE20A

ZSE20B(F)
ISE20B

ZSE20B(F)-L
ISE20B-L

ZSE20C(F)
ISE20C(H)

ZSE20C(F)-L
ISE20C(H)-L

Function
Details

Made to
Order

ZSE20□(F)/ISE20□ Series

Internal Circuits and Wiring Examples

ZSE20A(F)

ZSE20B(F)

ISE20A

ISE20B

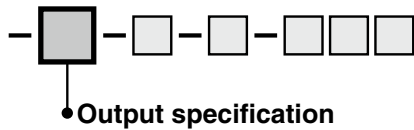

-R: NPN (2 outputs) + Auto-shift input

-S: NPN (2 outputs) + Auto-shift input

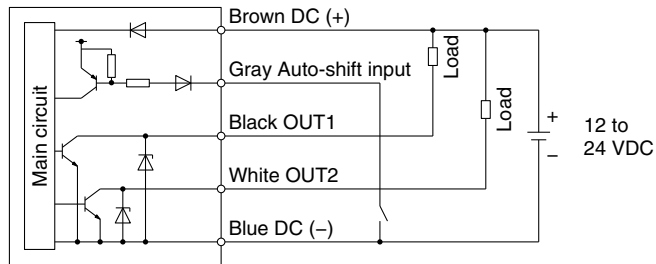

-T: PNP (2 outputs) + Auto-shift input

-V: PNP (2 outputs) + Auto-shift input

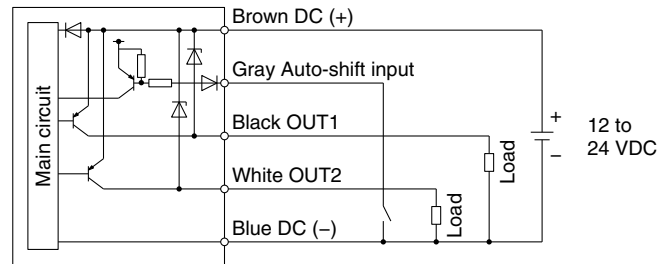

-R: NPN (2 outputs) + Copy function

-S: NPN (2 outputs) + Copy function

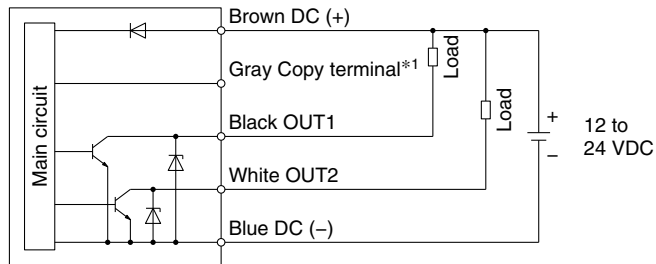

-T: PNP (2 outputs) + Copy function

-V: PNP (2 outputs) + Copy function

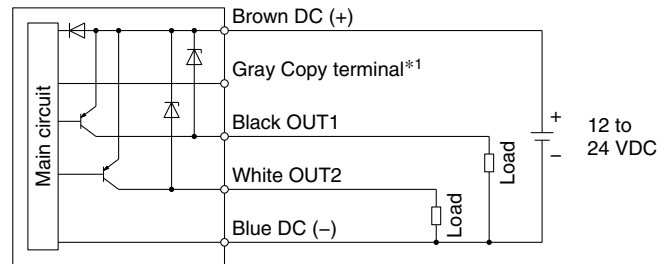

*1 Refer to page 41.

ZSE20B(F)

ISE20B

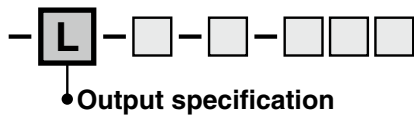

-L: (IO-Link/Switch: 1 output)

When used as a switch output device (When not used as an IO-Link device = When in SIO mode)

NPN open collector 1 output setting

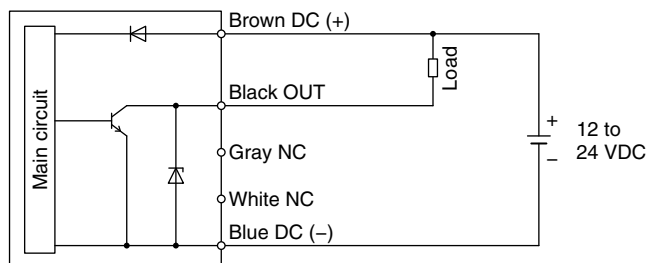

PNP open collector 1 output setting

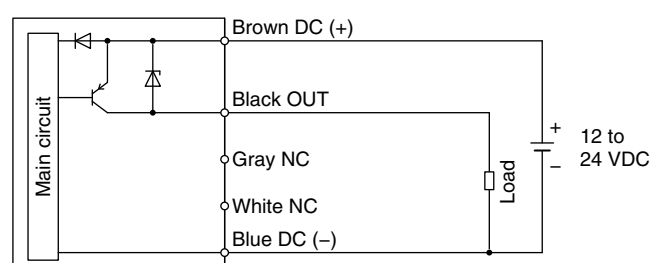

When used as an IO-Link device

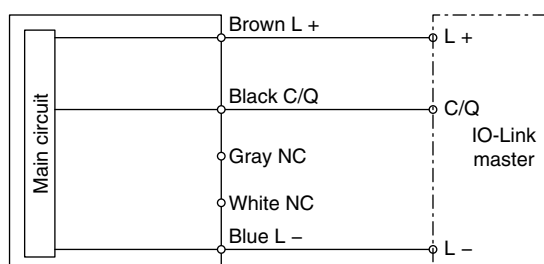

3-Screen Display High-Precision Digital Pressure Switch **ZSE20□(F)/ISE20□ Series**

Dimensions

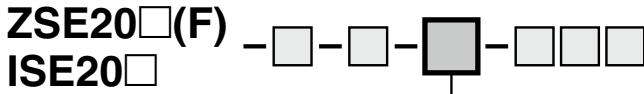

• Piping specification

M5
M5 female thread

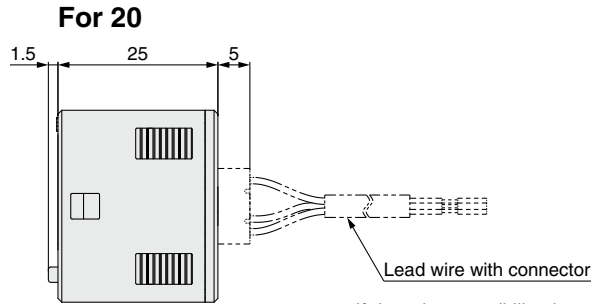

If there is a possibility that the atmospheric vent port of the switch will be exposed to water or dust, insert a tube into the atmospheric vent port and route the other end of the tube to a safe place away from water or dust. (Z/ISE20B)
* For tubing, please use the SMC TU0425 (polyurethane, O.D. $\phi 4$, I.D. $\phi 2.5$) for the pressure switch.

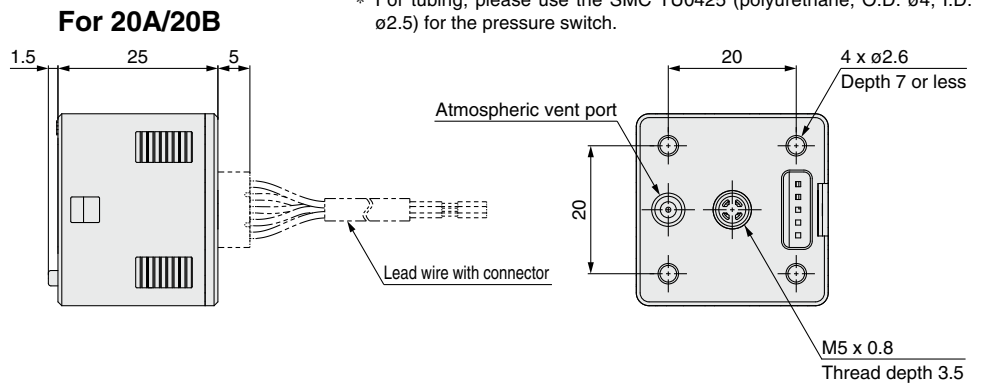
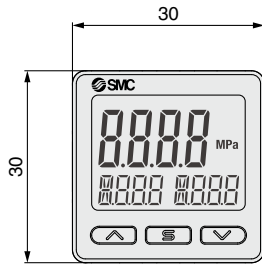

01
R1/8

N01
NPT1/8

| Piping specification | Port size | A |
|----------------------|-----------|-----------------------|
| 01 | R1/8 | Width across flats 10 |
| N01 | NPT1/8 | Width across flats 12 |

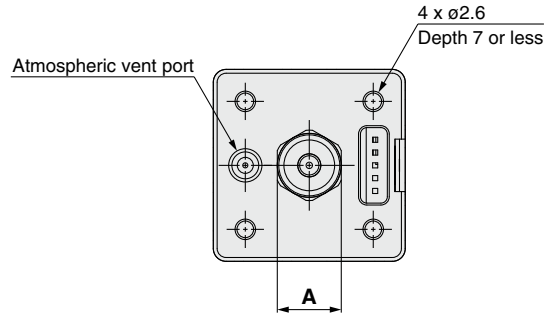
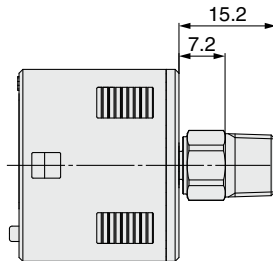

C4H, C6H, N7H

One-touch fitting Straight type
 $\phi 4$ mm, $\phi 6$ mm, $\phi 1/4$ inch

| Piping specification | A | B |
|----------------------|------|-------------|
| C4H | 15.6 | $\phi 8$ |
| C6H | 16.5 | $\phi 10$ |
| N7H | 16 | $\phi 10.3$ |

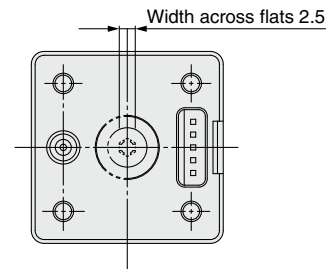
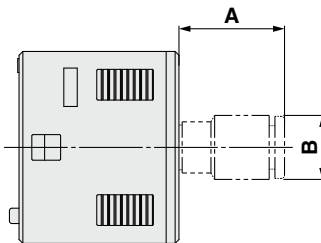

C4L, C6L, N7L

One-touch fitting Elbow type
 $\phi 4$ mm, $\phi 6$ mm, $\phi 1/4$ inch

| Piping specification | A | B | C | D |
|----------------------|------|------|---|-------------|
| C4L | 15.2 | 17.5 | 4 | $\phi 8.2$ |
| C6L | 15.2 | 18.3 | 4 | $\phi 10.4$ |
| N7L | 20.9 | 20.6 | 6 | $\phi 11.1$ |

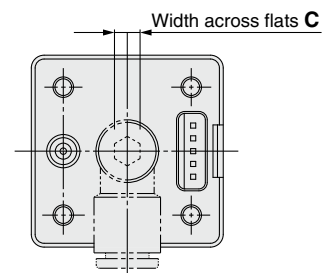
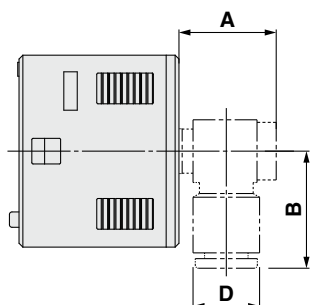

ZSE20□(F)/ISE20□ Series

Dimensions

With bracket

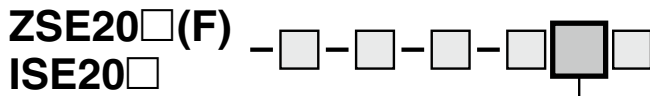

• Option 2

A1

Bracket A
 (Part no.: ZS-46-A1)

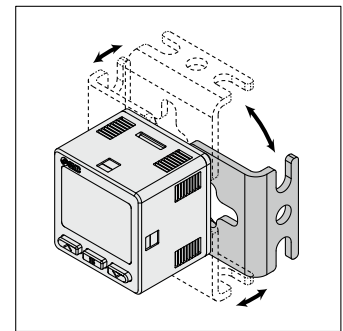
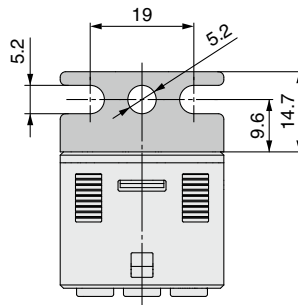
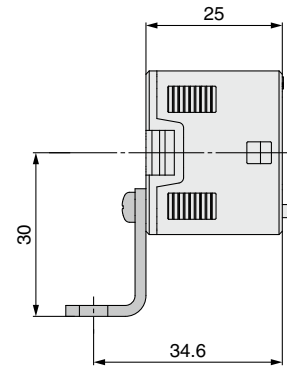
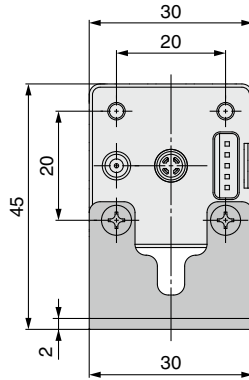

* The bracket configuration allows for mounting in four orientations.

A2

Bracket B
 (Part no.: ZS-46-A2)

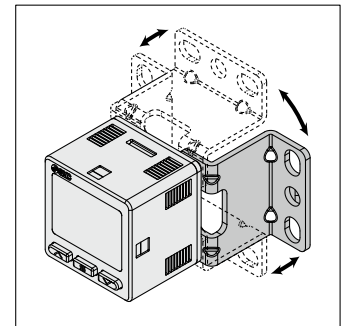
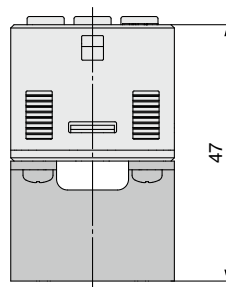

* The bracket configuration allows for mounting in four orientations.

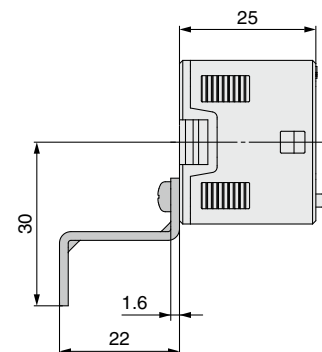
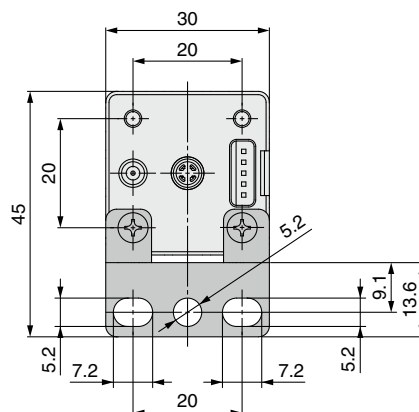

* When using the bracket B, install it by taking the dimensions of the piping part into consideration.

Dimensions

Panel mount adapter

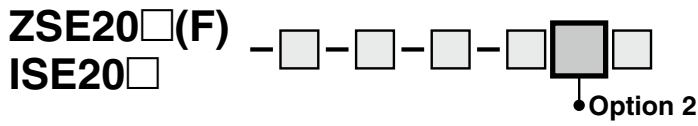

B Panel mount adapter (Part no.: ZS-46-B)

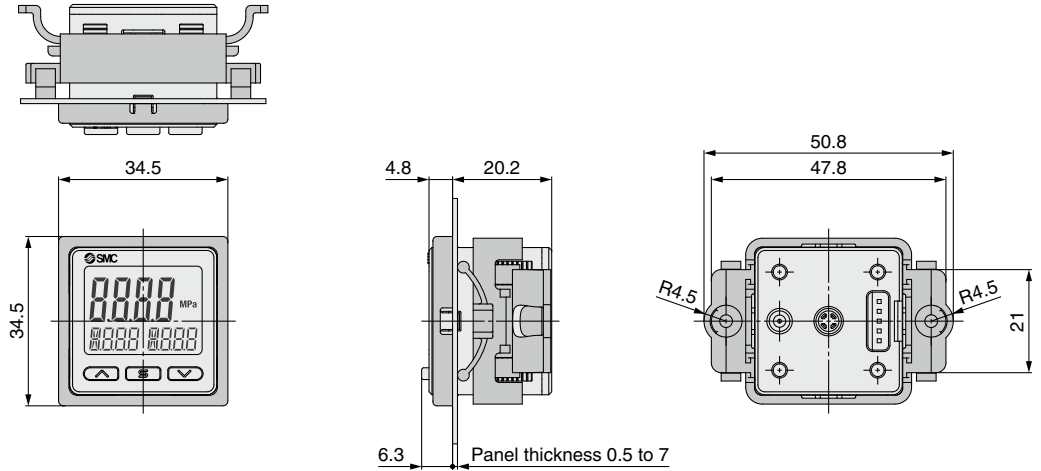

D Panel mount adapter + Front protection cover (Part no.: ZS-46-D)

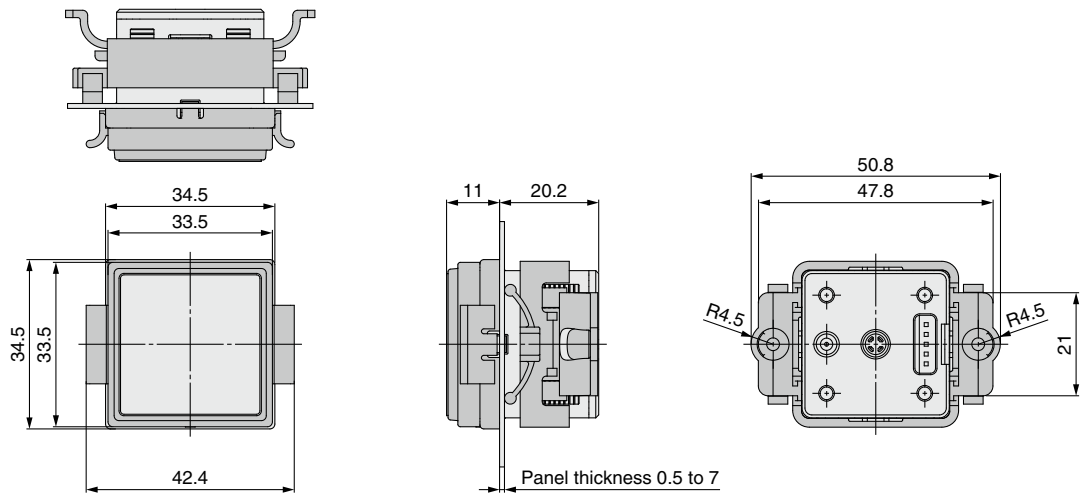

Lead wire with connector

For Z/ISE20(F) (Part no.: ZS-46-3L)

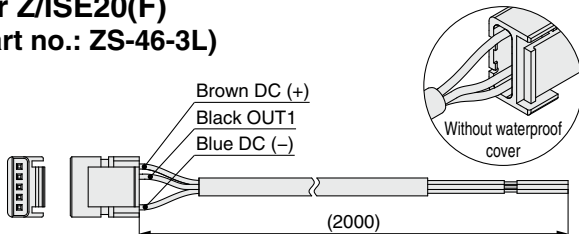

For Z/ISE20A(F) (Part no.: ZS-46-5L)

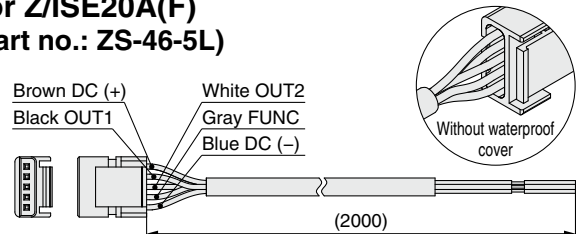

For Z/ISE20B(F)(-L) (Part no.: ZS-46-5F)

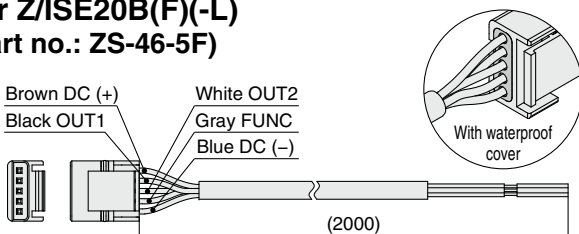

* For the lead wire with M12 connector, refer to page 43.

ZSE20□(F)/ISE20□ Series

Dimensions

Panel fitting dimensions

Individual mounting

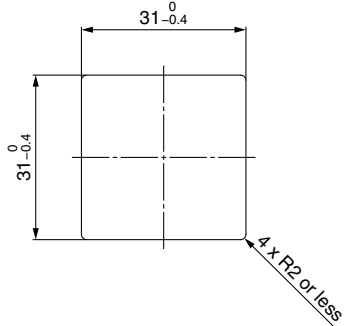

Multiple (2 pcs. or more) secure mounting <Horizontal>

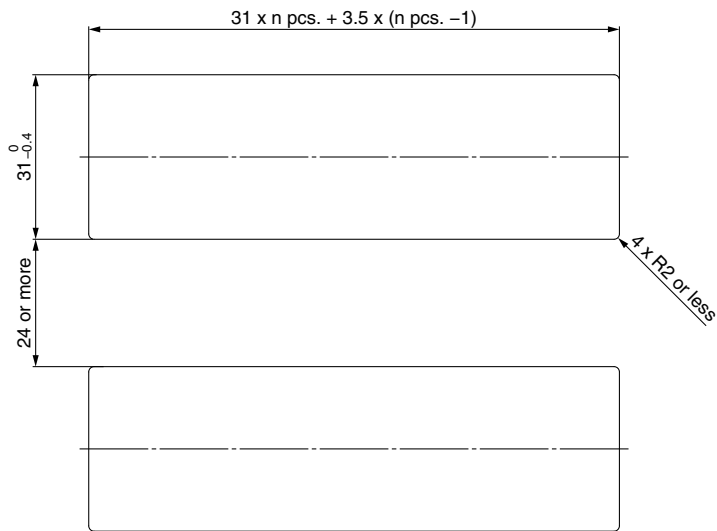

Panel mount example <Horizontal>

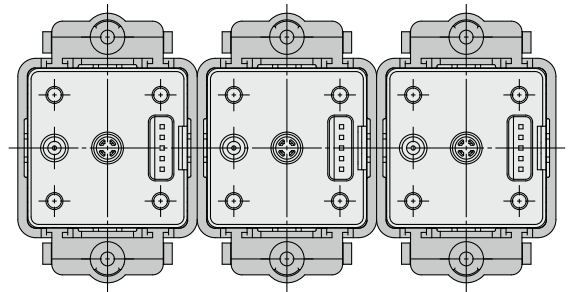

<Vertical>

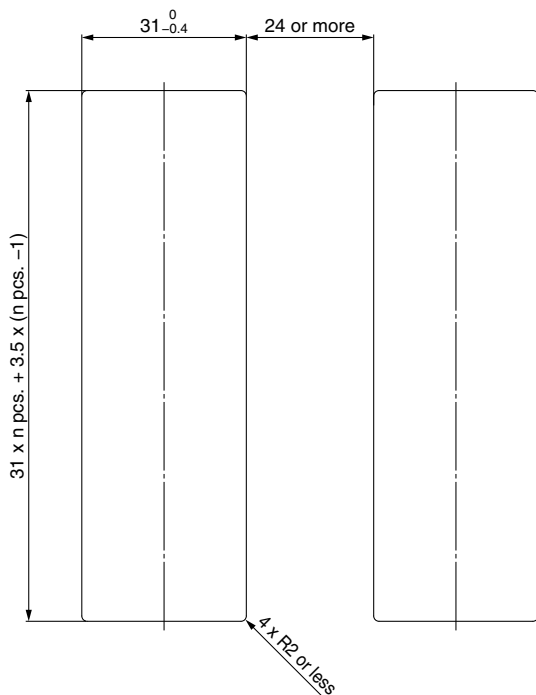

Panel mount example <Vertical>

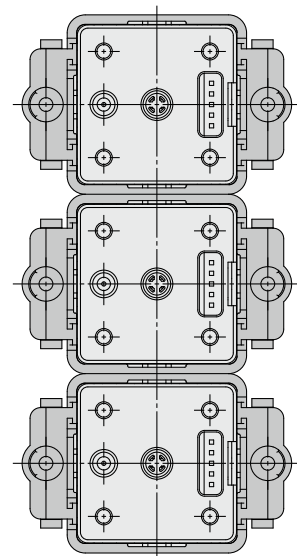

Made to
Order

Function
Details

ZSE20C(F)-L
ISE20C(H)-L

ZSE20C(F)
ISE20C(H)

ZSE20B(F)-L
ISE20B-L

ZSE20B(F)
ISE20B

ZSE20A(F)
ISE20A

ZSE20(F)
ISE20

2 Outputs + Analog Output (Voltage/Current)



3-Screen Display High-Precision Digital Pressure Switch for General Fluids

RoHS

IP65

ZSE20C(F)/ISE20C(H) Series

For the IO-Link compatible type, refer to page 27.

How to Order



Rated pressure range

| | |
|---------|---------------|
| ISE20C | -0.1 to 1 MPa |
| ISE20CH | -0.1 to 2 MPa |

For Positive Pressure

ISE20C - **X** - **M** - **02** [] - [] - [] - [] - []

For Vacuum/Compound Pressure

ZSE20C - **X** - **M** - **02** [] - [] - [] - [] - []

① ② ③ ④ ⑤ ⑥ ⑦ ⑧ • Made to order (pp. 42 to 48)

① Rated pressure range

| | |
|---------|-----------------|
| ZSE20C | 0 to -101 kPa |
| ZSE20CF | -100 to 100 kPa |

④ Piping specification

| Symbol | Description |
|--------|------------------------------|
| 02 | R1/4 (M5 female threaded) |
| N02 | NPT1/4 (M5 female threaded) |
| F02 | G1/4 (M5 female threaded) |
| C01 | Rc1/8 |
| A2 | URJ1/4 (Face seal fitting) |
| B2 | TSJ1/4 (Compression fitting) |

⑤ Piping direction

| | | |
|-----|---------------|--|
| Nil | Rear ported | |
| L | Bottom ported | |

② Output specification

| Symbol | Description |
|--------|--|
| R | NPN open collector 2 outputs + Analog voltage output*1 |
| S | NPN open collector 2 outputs + Analog current output*1 |
| T | PNP open collector 2 outputs + Analog voltage output*1 |
| V | PNP open collector 2 outputs + Analog current output*1 |
| X | NPN open collector 2 outputs + Copy function |
| Y | PNP open collector 2 outputs + Copy function |

*1 Can be switched to auto-shift or copy function

⑥ Option 1

| Symbol | Description |
|--------|---|
| Nil | Without lead wire |
| W | Lead wire with connector, 5-core (2 m lead wire, With waterproof cover) |

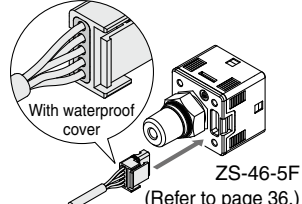

* For the lead wire with M12 connector, refer to page 43.

③ Unit specification

| Symbol | Description |
|--------|--|
| Nil | Units selection function*2 |
| M | SI units only*3 |
| P | Units selection function (Initial value psi)*3 |

*2 Under the New Measurement Act, switches with the units selection function are no longer allowed for use in Japan.
*3 Fixed units: kPa, MPa

⑦ Option 2

* Note that the optional parts that can be used vary depending on the piping direction.

| Symbol | Description |
|--------|-------------|
| Nil | None |

Rear ported (⑤ Piping direction: Nil)

| Symbol | Description | Symbol | Description |
|--------|--|--------|---------------------|
| A1 | Bracket A | B | Panel mount adapter |
| D | Panel mount adapter + Front protection cover | | |

Bottom ported (⑤ Piping direction: L)

| Symbol | Description |
|--------|--|
| A3 | Bracket C |
| E | Panel mount adapter |
| F | Panel mount adapter + Front protection cover |

Options/Part Nos.

When only optional parts are required, order with the part numbers listed below.

| Description | Part no. | Note |
|--|-------------|---|
| Bracket A | ZS-46-A1 | For rear ported/Tapping screw: Nominal size 3 x 8 L (2 pcs.) |
| Bracket C | ZS-46-E | For bottom ported/Tapping screw: Nominal size 3 x 10 L (2 pcs.) |
| Panel mount adapter | ZS-46-B | Rear ported |
| | ZS-35-B | Bottom ported |
| Panel mount adapter + Front protection cover | ZS-46-D | Rear ported |
| | ZS-35-E | Bottom ported |
| Panel mount adapter (Compatible with the panel holes of the ZISE80) | ZS-46-F | Rear ported, Made to order (Refer to page 46.) |
| Panel mount adapter + Front protection cover (Compatible with the panel holes of the ZISE80) | ZS-46-G | Rear ported, Made to order (Refer to page 46.) |
| Lead wire with connector | ZS-46-5F | 5-core, 2 m, Waterproof (With waterproof cover) |
| Lead wire with M12 connector | ZS-46-5FM12 | Made to order (Refer to page 43.) |
| Front protection cover | ZS-27-01 | Rear ported |
| | ZS-35-01 | Bottom ported |
| Adapter with restrictor Rc1/4 | ZS-31-X175 | To prevent the effects of water collision with inertia force Dimensions (Refer to page 32.) |
| Adapter with restrictor NPT1/4 | ZS-31-X186 | |
| Adapter with restrictor Rc1/8 | ZS-31-X188 | |
| Orifice M5 | ZS-48-A | To prevent the effects of water collision with inertia force Dimensions (Refer to page 32.) |

⑧ Option 3

| Symbol | Operation manual*4 | Calibration certificate*4 |
|--------|--------------------|---------------------------|
| Nil | ○ | — |
| Y | — | — |
| K | ○ | ○ |
| T | — | ○ |

*4 All texts are in both English and Japanese.

3-Screen Display High-Precision Digital Pressure Switch for General Fluids **ZSE20C(F)/ISE20C(H) Series**

For pressure switch precautions and specific product precautions, refer to the "Operation Manual" on the SMC website.



Specifications

| Model | | ZSE20C (Vacuum pressure) | ZSE20CF (Compound pressure) | ISE20C (Positive pressure) | ISE20CH (Positive pressure) | |
|---|---|--|---|------------------------------|------------------------------|--|
| Applicable fluid | | Liquids and gases that do not corrode stainless steel 630 and 304 | | | | |
| Pressure | Rated pressure range | 0.0 to -101.0 kPa | -100.0 to 100.0 kPa | -0.100 to 1.000 MPa | -0.100 to 2.000 MPa | |
| | Display/Set pressure range | 10.0 to -105.0 kPa | -105.0 to 105.0 kPa | -0.105 to 1.050 MPa | -0.105 to 2.100 MPa | |
| | Display/Smallest settable increment | 0.1 kPa | | 0.001 MPa | | |
| | Withstand pressure | 500 kPa | | 2 MPa | 4 MPa | |
| Power supply | Power supply voltage | 12 to 24 VDC ±10% with 10% voltage ripple or less | | | | |
| | Current consumption | 35 mA or less | | | | |
| | Protection | Polarity protection | | | | |
| Accuracy | Display accuracy | ±2% F.S. ±1 digit (Ambient temperature of 25 ±3°C) | | | | |
| | Repeatability | ±0.2% F.S. ±1 digit | | | | |
| | Analog output accuracy | ±2.5% F.S. (Ambient temperature of 25 ±3°C) | | | | |
| | Analog output linearity | ±1% F.S. | | | | |
| | Temperature characteristics | ±3% F.S. (25°C standard) | | | | |
| Switch output | Output type | NPN or PNP open collector 2 outputs | | | | |
| | Output mode | Hysteresis mode, Window comparator mode, Error output, Output OFF | | | | |
| | Switch operation | Normal output, Reversed output | | | | |
| | Max. load current | 80 mA | | | | |
| | Max. applied voltage (NPN only) | 28 V | | | | |
| | Internal voltage drop (Residual voltage) | 1 V or less (at load current of 80 mA) | | | | |
| | Delay time*1 | 1.5 ms or less (with anti-chattering function: 20, 100, 500, 1000, 2000, 5000 ms) | | | | |
| | Hysteresis | Hysteresis mode | Variable from 0*2 | | | |
| | | Window comparator mode | | | | |
| Short circuit protection | Yes | | | | | |
| Analog output | Voltage output | Output type | Voltage output: 1 to 5 V | Voltage output: 0.6 to 5 V | Voltage output: 0.8 to 5 V | |
| | | Output impedance | Approx. 1 kΩ | | | |
| | Current output | Output type | Current output: 4 to 20 mA | Current output: 2.4 to 20 mA | Current output: 3.2 to 20 mA | |
| | | Load impedance | Maximum load impedance at power supply voltage of 12 V: 300 Ω at power supply voltage of 24 V: 600 Ω Minimum load impedance: 50 Ω | | | |
| Auto-shift input | Input type | Non-voltage input: 0.4 V or less | | | | |
| | Input mode | Select from Auto-shift or Auto-shift zero. | | | | |
| | Input time | 5 ms or more | | | | |
| Display | Unit*3 | MPa, kPa, kgf/cm ² , bar, psi, inHg, mmHg | MPa, kPa, kgf/cm ² , bar, psi | | | |
| | Display type | LCD | | | | |
| | Number of screens | 3-screen display (Main screen, Sub screen x 2) | | | | |
| | Display color | 1) Main screen: Red/Green 2) Sub screen: Orange | | | | |
| | Number of display digits | 1) Main screen: 4 digits (7 segments) 2) Sub screen: 4 digits (Upper 1 digit 11 segments, 7 segments for other) | | | | |
| | Indicator light | Lights up when switch output is turned ON (OUT1, OUT2: Orange) | | | | |
| Digital filter*4 | 0, 10, 50, 100, 500, 1000, 5000 ms | | | | | |
| Environmental resistance | Enclosure | IP65 | | | | |
| | Withstand voltage | 250 VAC for 1 minute between terminals and housing | | | | |
| | Insulation resistance | 2 MΩ or more (50 VDC measured via megohmmeter) between terminals and housing | | | | |
| | Operating temperature range | Operating: -5 to 50°C, Stored: -10 to 60°C (No condensation or freezing) | | | | |
| | Operating humidity range | Operating/Stored: 35 to 85% RH (No condensation) | | | | |
| Standards | UL/CSA (E216656), CE/UKCA marking | | | | | |
| Length of lead wire with connector | 2 m | | | | | |

*1 Value without digital filter (at 0 ms)

*2 If the applied pressure fluctuates around the set value, the hysteresis must be set to a value greater than the amount of fluctuation, or chattering will occur.

*3 Setting is only possible for models with the units selection function. Only MPa or kPa is available for models without this function.

*4 The response time indicates when the set value is 90% in relation to the step input.

* Products with tiny scratches, marks, or display color or brightness variations which do not affect the performance of the product are verified as conforming products.

Piping Specifications and Weights

| Model | 02 | N02 | F02 | C01 | A2 | B2 | |
|---|---|--------|------|-------|--------|--------|------|
| Port size | R1/4 | NPT1/4 | G1/4 | Rc1/8 | URJ1/4 | TSJ1/4 | |
| Materials of parts in contact with fluid | Pressure sensor: Stainless steel 630, Fitting: Stainless steel 304, Grease-free | | | | | | |
| Weight | Body (Rear ported) | 51 g | 51 g | 48 g | 47 g | 54 g | 46 g |
| | Body (Bottom ported) | 77 g | 78 g | 74 g | 65 g | 81 g | 72 g |
| | Lead wire with connector | +39 g | | | | | |

Cable Specifications

| | | |
|--------------------------------|------------------------------|--|
| Conductor cross section | 0.15 mm ² (AWG26) | |
| Insulator | O.D. | 1.0 mm |
| | Color | Brown, Blue, Black, White, Gray (5-core) |
| Sheath | Finished O.D. | ø3.5 |

ZSE20(F)
ISE20

ZSE20A(F)
ISE20A

ZSE20B(F)
ISE20B

ZSE20B(F)-L
ISE20B-L

ZSE20C(F)
ISE20C(H)

ZSE20C(F)-L
ISE20C(H)-L

Function
Details

Made to
Order

IO-Link Compatible (1 Output)



RoHS

IP65

3-Screen Display High-Precision

Digital Pressure Switch for General Fluids

ZSE20C(F)-L/ISE20C(H)-L Series

For 2 outputs + analog output type, refer to page 25.

How to Order



Rated pressure range

| | |
|---------|---------------|
| ISE20C | -0.1 to 1 MPa |
| ISE20CH | -0.1 to 2 MPa |

For Positive Pressure

ISE20C - L - M - 02

For Vacuum/
Compound Pressure

ZSE20C - L - M - 02

1 2 3 4 5 6 7 8

1 Rated pressure range

| | |
|---------|-----------------|
| ZSE20C | 0 to -101 kPa |
| ZSE20CF | -100 to 100 kPa |

2 Output specification

| Symbol | Description |
|--------|--|
| L | IO-Link/Switch: 1 output ← (PNP or NPN switching type for switch output) |

7 Option 2

* Note that the optional parts that can be used vary depending on the piping direction.

| Symbol | Description |
|--------|-------------|
| Nil | None |

3 Unit specification

| Symbol | Description |
|--------|--|
| Nil | Units selection function*1 |
| M | SI units only*2 |
| P | Units selection function (Initial value psi)*1 |

*1 Under the New Measurement Act, switches with the units selection function are no longer allowed for use in Japan.

*2 Fixed units: kPa, MPa

4 Piping specification

| Symbol | Description |
|--------|-------------------------------|
| 02 | R1/4 (M5 female threaded) |
| N02 | NPT1/4 (M5 female threaded) |
| F02 | G1/4 (M5 female threaded) |
| C01 | Rc1/8 |
| A2 | URJ1/4 (Face seal fitting) |
| B2 | T SJ1/4 (Compression fitting) |

Rear ported (5 Piping direction: Nil)

| Symbol | Description | Symbol | Description |
|--------|--|--------|---------------------|
| A1 | Bracket A | B | Panel mount adapter |
| D | Panel mount adapter + Front protection cover | | |

5 Piping direction

| | |
|-----|---------------|
| Nil | Rear ported |
| L | Bottom ported |

6 Option 1

| Symbol | Description |
|--------|---|
| Nil | Without lead wire |
| W | Lead wire with connector, 5-core (2 m lead wire, With waterproof cover) |

* For the lead wire with M12 connector, refer to page 43.

Bottom ported (5 Piping direction: L)

| Symbol | Description |
|--------|--|
| A3 | Bracket C |
| E | Panel mount adapter |
| F | Panel mount adapter + Front protection cover |

Options/Part Nos.

When only optional parts are required, order with the part numbers listed below.

| Description | Part no. | Note |
|--|-------------|---|
| Bracket A | ZS-46-A1 | For rear ported/Tapping screw: Nominal size 3 x 8 L (2 pcs.) |
| Bracket C | ZS-46-E | For bottom ported/Tapping screw: Nominal size 3 x 10 L (2 pcs.) |
| Panel mount adapter | ZS-46-B | Rear ported |
| | ZS-35-B | Bottom ported |
| Panel mount adapter + Front protection cover | ZS-46-D | Rear ported |
| | ZS-35-E | Bottom ported |
| Lead wire with connector | ZS-46-5F | 5-core, 2 m, Waterproof (With waterproof cover) |
| Lead wire with M12 connector | ZS-46-5FM12 | Made to order (Refer to page 43.) |
| | | |
| Front protection cover | ZS-27-01 | Rear ported |
| | ZS-35-01 | Bottom ported |
| Adapter with restrictor Rc1/4 | ZS-31-X175 | To prevent the effects of water collision with inertia force Dimensions (Refer to page 32.) |
| Adapter with restrictor NPT1/4 | ZS-31-X186 | |
| Adapter with restrictor Rc1/8 | ZS-31-X188 | |
| Orifice M5 | ZS-48-A | To prevent the effects of water collision with inertia force Dimensions (Refer to page 32.) |

8 Option 3

| Symbol | Operation manual*3 | Calibration certificate*3 |
|--------|--------------------|---------------------------|
| Nil | ○ | — |
| Y | — | — |
| K | ○ | ○ |
| T | — | ○ |

*3 All texts are in both English and Japanese.

For pressure switch precautions and specific product precautions, refer to the "Operation Manual" on the SMC website.



Specifications

| Model | | ZSE20C-L (Vacuum pressure) | ZSE20CF-L (Compound pressure) | ISE20C-L (Positive pressure) | ISE20CH-L (Positive pressure) | |
|---|---|---|----------------------------------|--|----------------------------------|--|
| Applicable fluid | | Liquids and gases that do not corrode stainless steel 630 and 304 | | | | |
| Pressure | Rated pressure range | 0.0 to -101.0 kPa | -100.0 to 100.0 kPa | -0.100 to 1.000 MPa | -0.100 to 2.000 MPa | |
| | Display/Set pressure range | 10.0 to -105.0 kPa | -105.0 to 105.0 kPa | -0.105 to 1.050 MPa | -0.105 to 2.100 MPa | |
| | Display/Smallest settable increment | 0.1 kPa | | 0.001 MPa | | |
| | Withstand pressure | 500 kPa | | 2 MPa | 4 MPa | |
| Power supply | Power supply voltage | When used as a switch output device (When not used as an IO-Link device) 12 to 24 VDC ±10% with 10% voltage ripple (p-p) or less When used as an IO-Link device 18 to 30 VDC, including ripple (p-p) 10% | | | | |
| | Current consumption | 35 mA or less | | | | |
| | Protection | Polarity protection | | | | |
| Accuracy | Display accuracy | ±2% F.S. ±1 digit (Ambient temperature of 25 ±3°C) | | | | |
| | Repeatability | ±0.2% F.S. ±1 digit | | | | |
| | Temperature characteristics | ±3% F.S. (25°C standard) | | | | |
| Switch output (SIO mode) | Output type | Select from NPN or PNP open collector output. | | | | |
| | Output mode | Hysteresis mode, Window comparator mode, Error output, Output OFF | | | | |
| | Switch operation | Normal output, Reversed output | | | | |
| | Max. load current | 80 mA | | | | |
| | Max. applied voltage (NPN only) | 28 V | | | | |
| | Internal voltage drop (Residual voltage) | 1.5 V or less (at load current of 80 mA) | | | | |
| | Delay time*1 | 1.5 ms or less, variable from 0 to 60 s/0.01 s increments | | | | |
| | Hysteresis | Hysteresis mode | Variable from 0*2 | | | |
| | | Window comparator mode | | | | |
| | Short circuit protection | Yes | | | | |
| Display | Unit*3 | MPa, kPa, kgf/cm ² , bar, psi, inHg, mmHg | | MPa, kPa, kgf/cm ² , bar, psi | | |
| | Display type | LCD | | | | |
| | Number of screens | 3-screen display (Main screen, Sub screen x 2) | | | | |
| | Display color | 1) Main screen: Red/Green 2) Sub screen: Orange | | | | |
| | Number of display digits | 1) Main screen: 4 digits (7 segments) 2) Sub screen: 4 digits (Upper 1 digit 11 segments, 7 segments for other) | | | | |
| | Indicator light | Lights up when switch output is turned ON (OUT1, OUT2: Orange) | | | | |
| Digital filter*4 | | Variable from 0 to 30 s/0.01 s increments | | | | |
| Environmental resistance | Enclosure | IP65 | | | | |
| | Withstand voltage | 250 VAC for 1 minute between terminals and housing | | | | |
| | Insulation resistance | 2 MΩ or more (50 VDC measured via megohmmeter) between terminals and housing | | | | |
| | Operating temperature range | Operating: -5 to 50°C, Stored: -10 to 60°C (No condensation) | | | | |
| | Operating humidity range | Operating/Stored: 35 to 85% RH (No condensation) | | | | |
| Standards | | CE/UKCA marking | | | | |
| Length of lead wire with connector | | 2 m | | | | |
| Communication (IO-Link mode) | IO-Link type | Device | | | | |
| | IO-Link version | V1.1 | | | | |
| | Communication speed | COM2 (38.4 kbps) | | | | |
| | Configuration file | IODD file*5 | | | | |
| | Minimum cycle time | 2.3 ms | | | | |
| | Process data length | Input data: 2 bytes, Output data: 0 bytes | | | | |
| | On request data communication | Yes | | | | |
| | Data storage function | Yes | | | | |
| | Event function | Yes | | | | |
| | Vendor ID | 131 (0 x 000083) | | | | |

*1 Value without digital filter (at 0 ms)

*2 If the applied pressure fluctuates around the set value, the hysteresis must be set to a value greater than the amount of fluctuation, or chattering will occur.

*3 Setting is only possible for models with the units selection function. Only MPa or kPa is available for models without this function.

*4 The response time indicates when the set value is 90% in relation to the step input.

*5 The configuration file can be downloaded from the SMC website, <https://www.smcworld.com>

* Products with tiny scratches, marks, or display color or brightness variations which do not affect the performance of the product are verified as conforming products.

Piping Specifications and Weights

| Model | 02 | N02 | F02 | C01 | A2 | B2 | |
|---|---|--------|------|-------|--------|--------|------|
| Port size | R1/4 | NPT1/4 | G1/4 | Rc1/8 | URJ1/4 | TSJ1/4 | |
| Materials of parts in contact with fluid | Pressure sensor: Stainless steel 630, Fitting: Stainless steel 304, Grease-free | | | | | | |
| Weight | Body (Rear ported) | 51 g | 51 g | 48 g | 47 g | 54 g | 46 g |
| | Body (Bottom ported) | 77 g | 78 g | 74 g | 65 g | 81 g | 72 g |
| | Lead wire with connector | +39 g | | | | | |

Cable Specifications

| | | |
|--------------------------------|----------------------|--|
| Conductor cross section | | 0.15 mm ² (AWG26) |
| Insulator | O.D. | 1.0 mm |
| | Color | Brown, Blue, Black, White, Gray (5-core) |
| Sheath | Finished O.D. | ø3.5 |

ZSE20(F)
ISE20

ZSE20A(F)
ISE20A

ZSE20B(F)
ISE20B

ZSE20B(F)-L
ISE20B-L

ZSE20C(F)
ISE20C(H)

ZSE20C(F)-L
ISE20C(H)-L

Function
Details

Made to
Order

ZSE20C(F)/ISE20C(H) Series

Set Pressure Range and Rated Pressure Range

Set the pressure within the rated pressure range.

The set pressure range is the range of pressure within which setting is possible. The rated pressure range is the range of pressure that satisfies the specifications (accuracy, linearity, etc.) of the switch. Although it is possible to set a value outside the rated pressure range, the specifications cannot be guaranteed even if the value stays within the set pressure range.

| Switch | | Pressure range | | | | | |
|-----------------------|----------------------|--------------------------|--------|---------|---------|----------|---------|
| | | -100 kPa | 0 | 100 kPa | 500 kPa | 1 MPa | 2 MPa |
| For vacuum pressure | ZSE20C ZSE20C-L | -101 kPa | 0 | | | | |
| | | -105 kPa | 10 kPa | | | | |
| For compound pressure | ZSE20CF ZSE20CF-L | -100 kPa | | 100 kPa | | | |
| | | -105 kPa | | 105 kPa | | | |
| For positive pressure | ISE20C ISE20C-L | -100 kPa | | | | 1 MPa | |
| | | -105 kPa (-0.105 MPa) | | | | 1.05 MPa | |
| | ISE20CH ISE20CH-L | -100 kPa | | | | | 2 MPa |
| | | -105 kPa (-0.105 MPa) | | | | | 2.1 MPa |

Rated pressure range of the switch
 Set pressure range of the switch

Analog Output

Voltage output

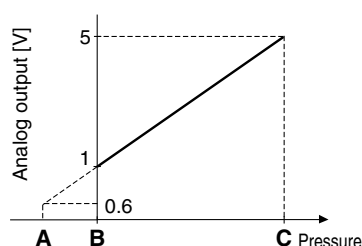

Current output

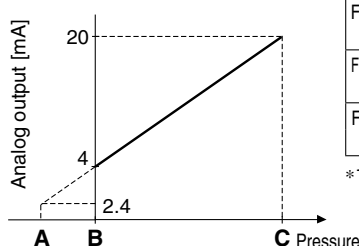

| Range | Rated pressure range | A | B | C |
|-----------------------|----------------------|--------------------------|------------|------------|
| For vacuum pressure | 0.0 to -101.0 kPa | 10.1 kPa | 0 | -101.0 kPa |
| For compound pressure | -100.0 to 100.0 kPa | — | -100.0 kPa | 100.0 kPa |
| For positive pressure | -0.100 to 1.000 MPa | -0.100 MPa | 0 | 1.000 MPa |
| | -0.100 to 2.00 MPa | -0.100 MPa ^{*1} | 0 | 2.00 MPa |

*1 Analog output is 0.8 [V] or 3.2 [mA] at the pressure A.

* Excludes the 20C(F/H)-L

IO-Link: Process Data

Relationship between the process data and pressure value

ZSE20C-L (For vacuum pressure)

Process data

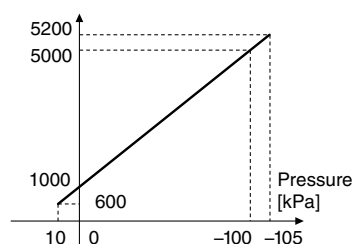

ZSE20CF-L (For compound pressure)

Process data

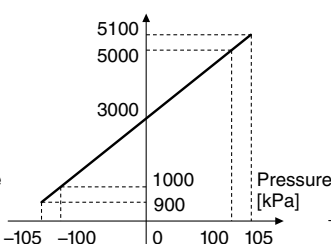

ISE20C-L (For positive pressure)

Process data

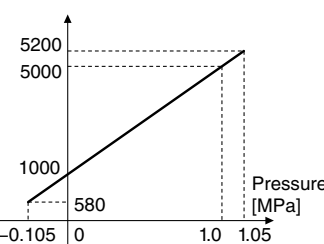

ISE20CH-L (For positive pressure)

Process data

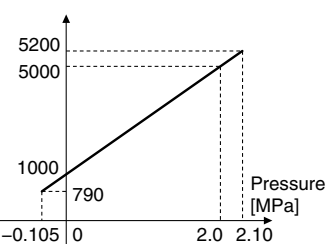

Functions

| | |
|--|---|
| Sub screen setting function | The display of the sub screen can be selected. |
| Auto-preset function | This function calculates a rough set value automatically based on the on-going operation. |
| Display value fine adjustment function | Evens out deviations in the displayed value |
| Peak value indication function | Can retain the maximum pressure value displayed during measurement |
| Bottom value indication function | Can retain the minimum pressure value displayed during measurement |
| Key-lock function (Selectable security code) | The keyboard can be locked to prevent the accidental operation of the operation switch. |
| Zero-clear function | The pressure display can be set to zero when the pressure is open to the atmosphere. |
| Error indication function | This function displays the error location and content when a problem or error has occurred. |
| Anti-chattering function | Prevents possible malfunctions due to sudden fluctuations in the primary pressure by adjusting the delay time |
| Units selection function | Can convert the display value |
| Power saving mode | Reduces power consumption |
| Display resolution switch function | Converts the display resolution from the normal value of 1/1000 to 1/100 Can reduce flickering of the monitor |
| kPa ↔ MPa switch function | Converts the unit between kPa and MPa |
| Copy function ^{*1} | The settings of the copy source can be copied to the copy destination. |
| Auto-shift function ^{*1} | Measures the pressure at the time of external input and uses it as a reference to correct the set value of the switch |

*1 Not available for the 20C(F/H)-L

Internal Circuits and Wiring Examples

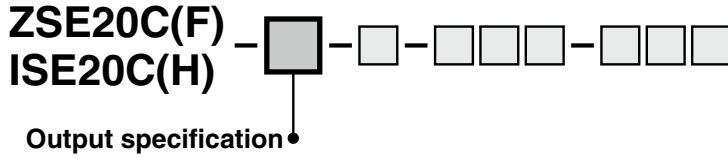

-X
NPN (2 outputs) + Copy function

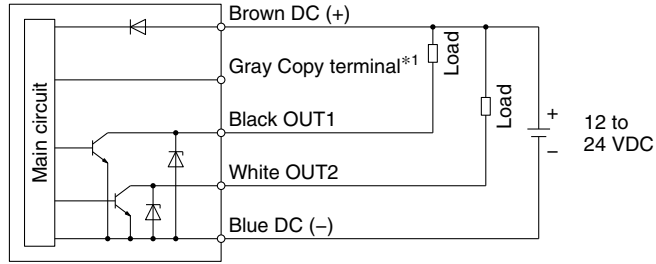

-Y
PNP (2 outputs) + Copy function

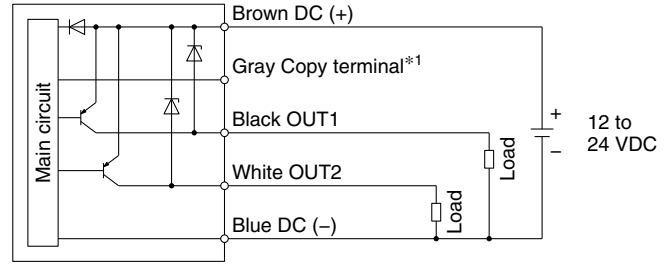

-R: NPN (2 outputs) + Analog voltage output
-S: NPN (2 outputs) + Analog current output

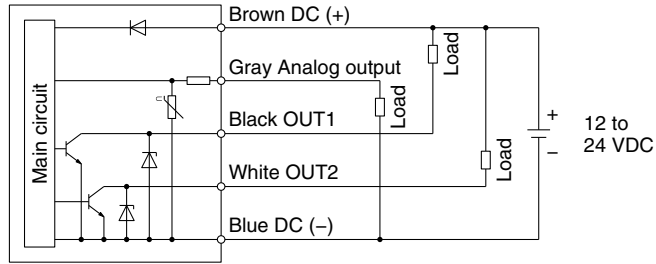

-T: PNP (2 outputs) + Analog voltage output
-V: PNP (2 outputs) + Analog current output

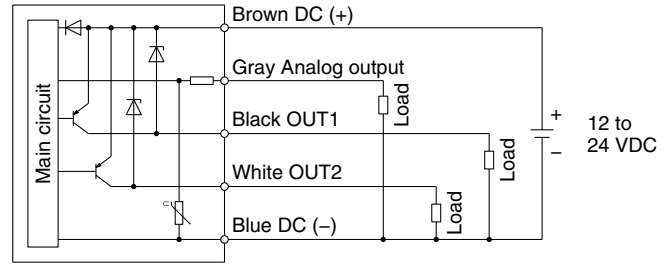

-R: NPN (2 outputs) + Auto-shift input
-S: NPN (2 outputs) + Auto-shift input

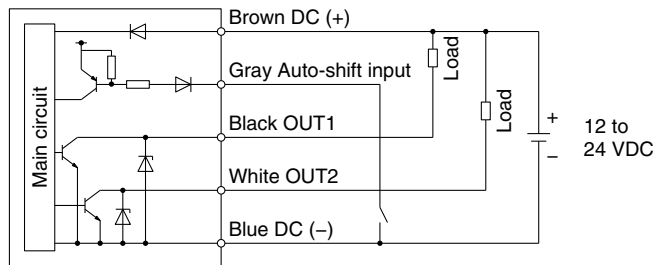

-T: PNP (2 outputs) + Auto-shift input
-V: PNP (2 outputs) + Auto-shift input

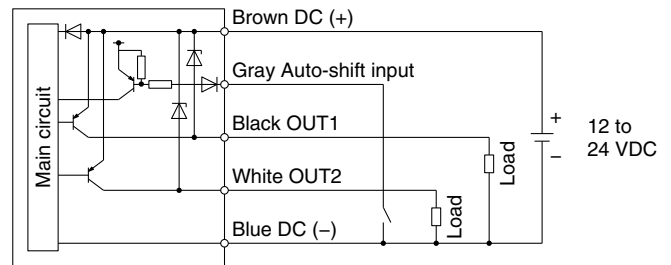

-R: NPN (2 outputs) + Copy function
-S: NPN (2 outputs) + Copy function

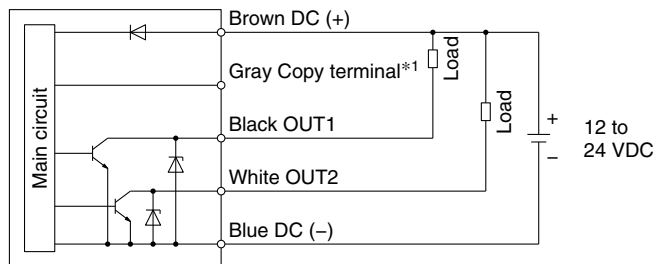

-T: PNP (2 outputs) + Copy function
-V: PNP (2 outputs) + Copy function

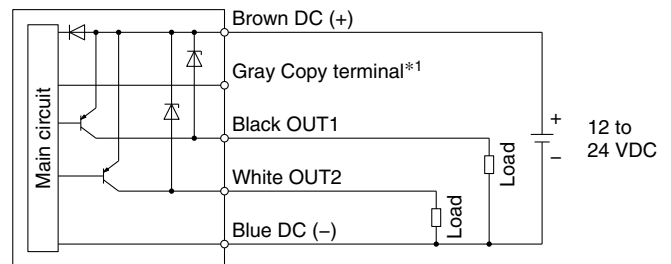

*1 Refer to page 41.

ZSE20(F)
ISE20

ZSE20A(F)
ISE20A

ZSE20B(F)
ISE20B

ZSE20B(F)-L
ISE20B-L

ZSE20C(F)
ISE20C(H)

ZSE20C(F)-L
ISE20C(H)-L

Function
Details

Made to
Order

ZSE20C(F)/ISE20C(H) Series

Internal Circuits and Wiring Examples

ZSE20C(F)
ISE20C(H) - **L** - □ - □ □ - □ □ □

Output specification

-L: (IO-Link/Switch: 1 output)

When used as a switch output device (When not used as an IO-Link device = When in SIO mode)

NPN open collector 1 output setting

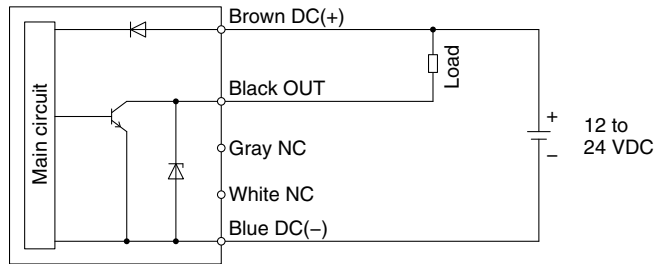

PNP open collector 1 output setting

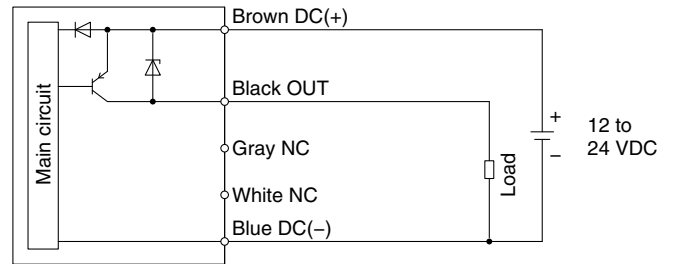

When used as an IO-Link device

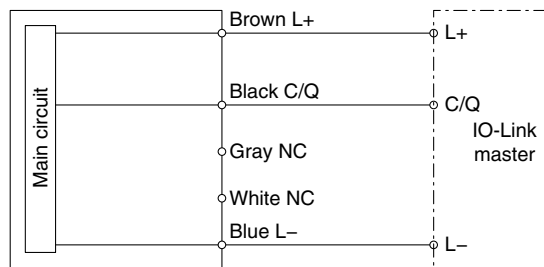

3-Screen Display High-Precision Digital Pressure Switch for General Fluids **ZSE20C(F)/ISE20C(H) Series**

Dimensions

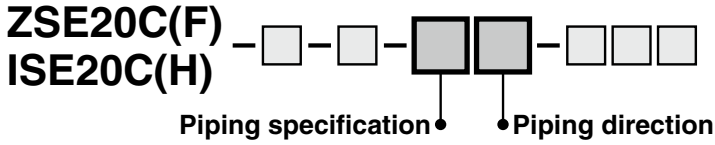

02

R1/4

N02

NPT1/4

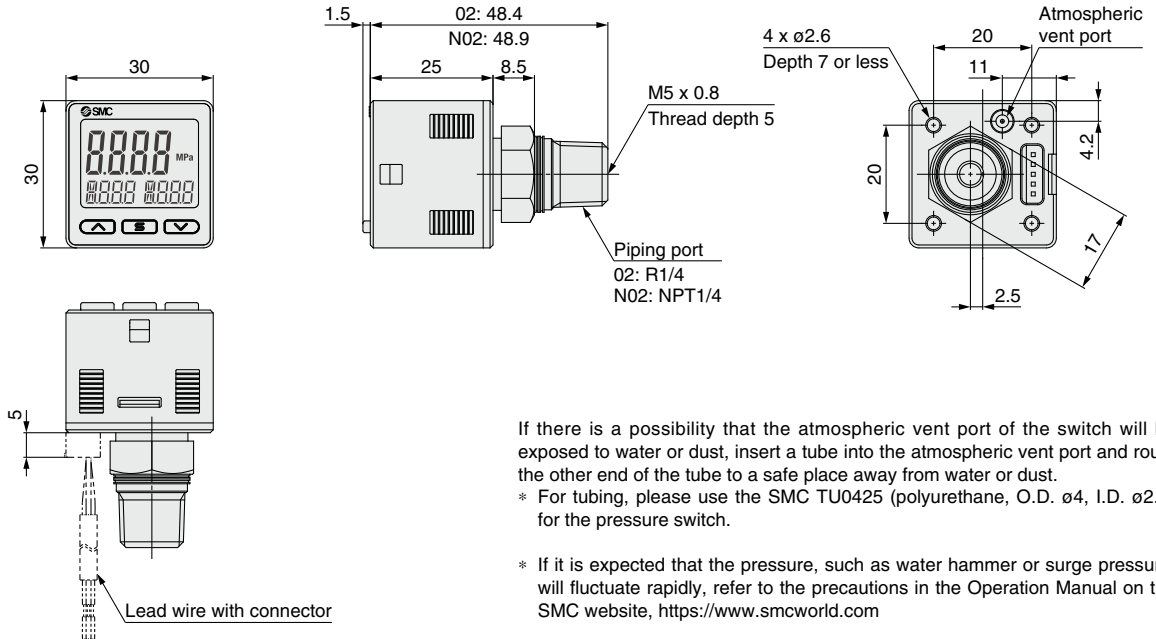

If there is a possibility that the atmospheric vent port of the switch will be exposed to water or dust, insert a tube into the atmospheric vent port and route the other end of the tube to a safe place away from water or dust.

* For tubing, please use the SMC TU0425 (polyurethane, O.D. ø4, I.D. ø2.5) for the pressure switch.

* If it is expected that the pressure, such as water hammer or surge pressure, will fluctuate rapidly, refer to the precautions in the Operation Manual on the SMC website, <https://www.smcworld.com>

F02

G1/4

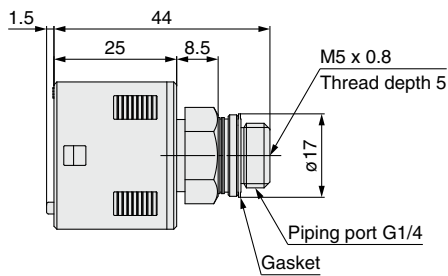

C01

Rc1/8

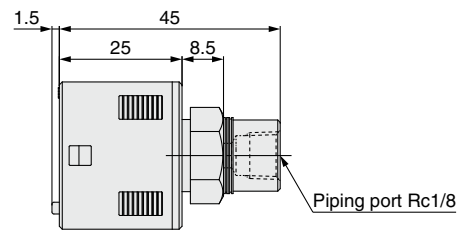

A2

URJ1/4

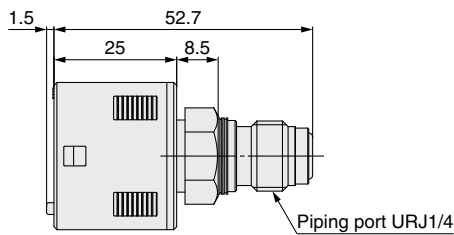

B2

TSJ1/4

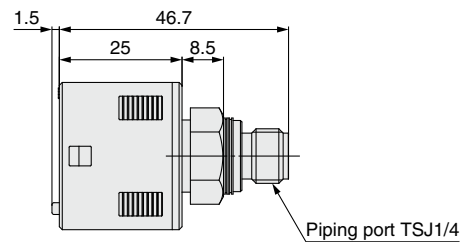

Adapter with restrictor
ZS-31-X□□□
Material: Stainless steel 304

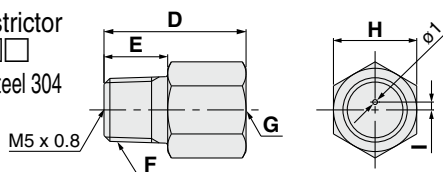

Orifice
ZS-48-A

Material: Stainless steel 303

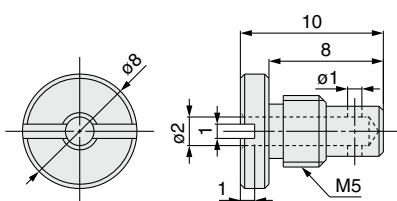

| Part no. | D | E | F | G | H | I |
|-------------------|----|----|--------|--------|----|-----|
| ZS-31-X188 | 20 | 9 | R1/8 | Rc1/8 | 14 | 1.5 |
| ZS-31-X175 | 29 | 13 | R1/4 | Rc1/4 | 17 | 1.6 |
| ZS-31-X186 | 29 | 13 | NPT1/4 | NPT1/4 | 17 | 1.6 |

[mm]

* If it is expected that the pressure, such as water hammer or surge pressure, will fluctuate rapidly, refer to the precautions in the Operation Manual on the SMC website, <https://www.smcworld.com>

ZSE20C(F)/ISE20C(H) Series

Dimensions

ZSE20C(F)
ISE20C(H)

Piping specification Piping direction

O2L

R1/4

N02L

NPT1/4

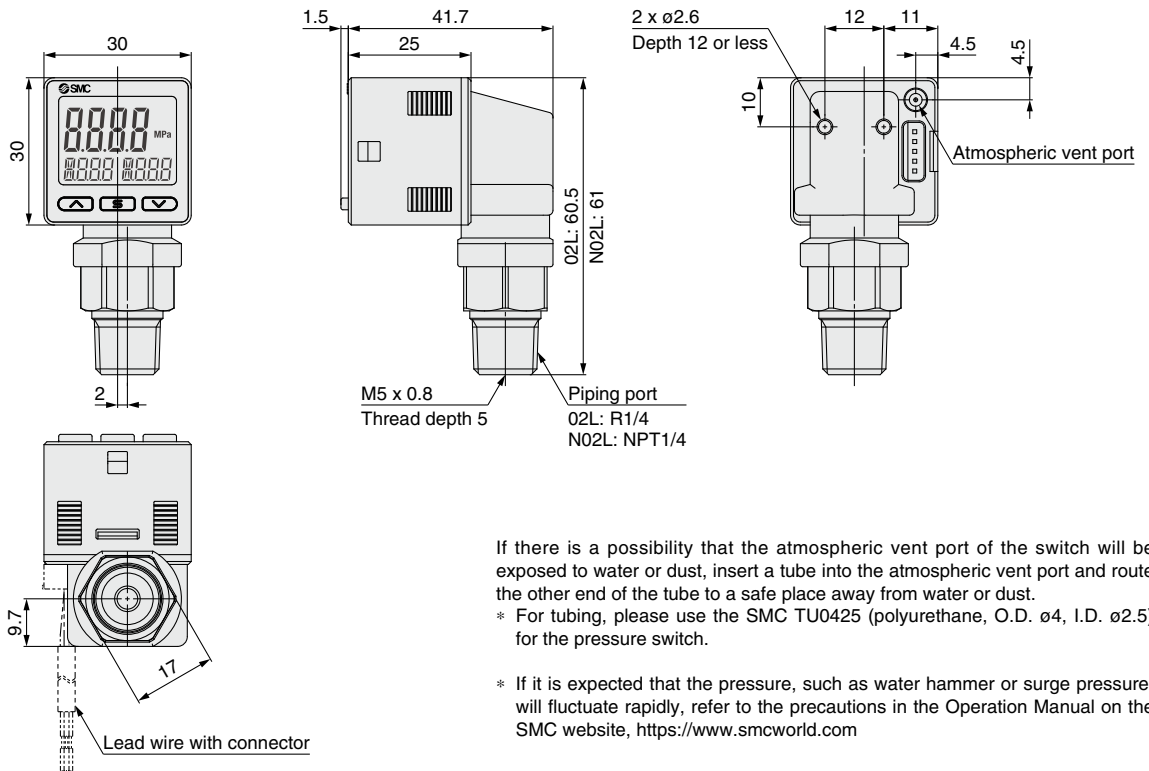

If there is a possibility that the atmospheric vent port of the switch will be exposed to water or dust, insert a tube into the atmospheric vent port and route the other end of the tube to a safe place away from water or dust.

* For tubing, please use the SMC TU0425 (polyurethane, O.D. ø4, I.D. ø2.5) for the pressure switch.

* If it is expected that the pressure, such as water hammer or surge pressure, will fluctuate rapidly, refer to the precautions in the Operation Manual on the SMC website, <https://www.smcworld.com>

F02L

G1/4

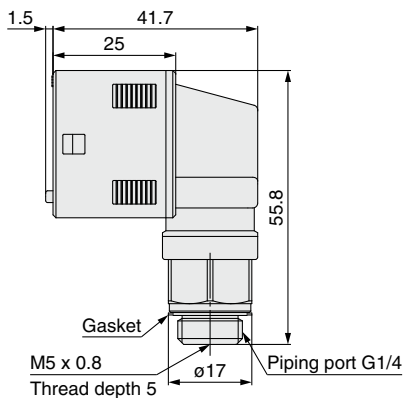

C01L

Rc1/8

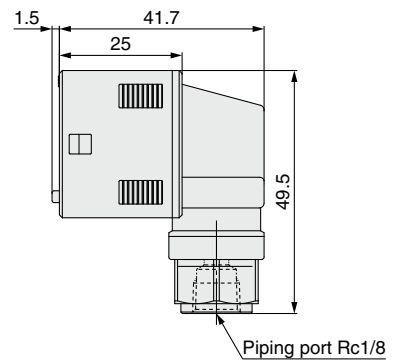

A2L

URJ1/4

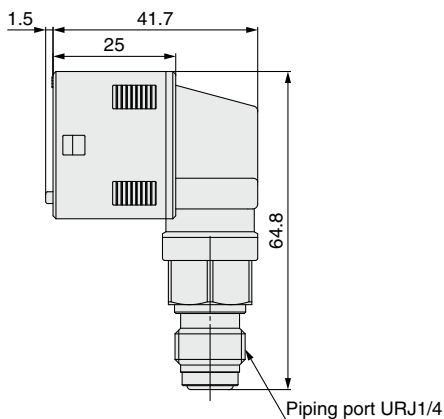

B2L

TSJ1/4

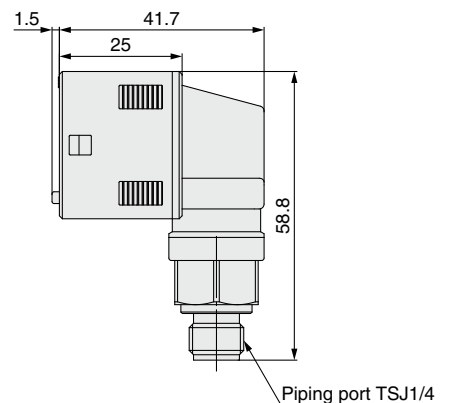

Dimensions

With bracket

ZSE20C(F)
ISE20C(H)



• Option 2

A1

Bracket A (Rear ported)
(Part no.: ZS-46-A1)

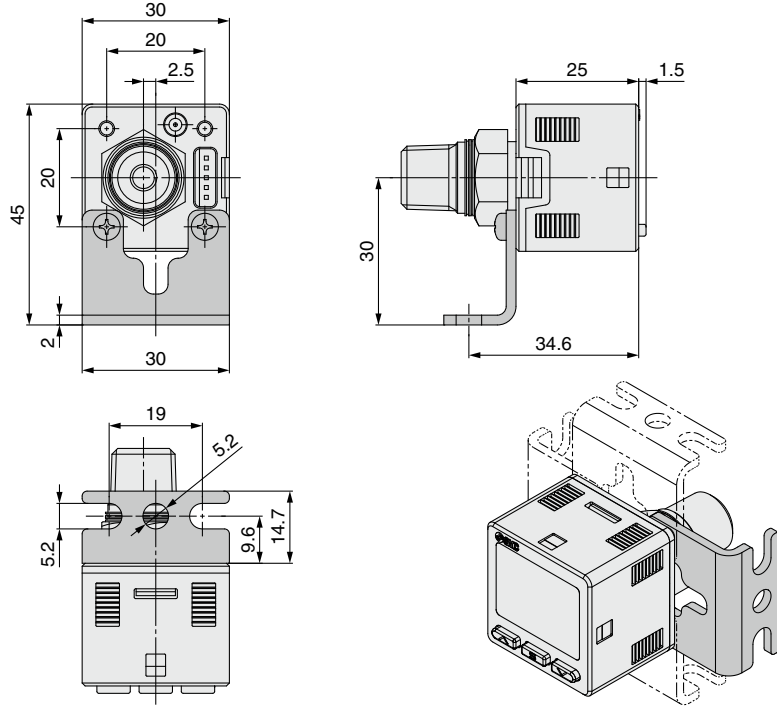

A3

Bracket C (Bottom ported)
(Part no.: ZS-46-E)

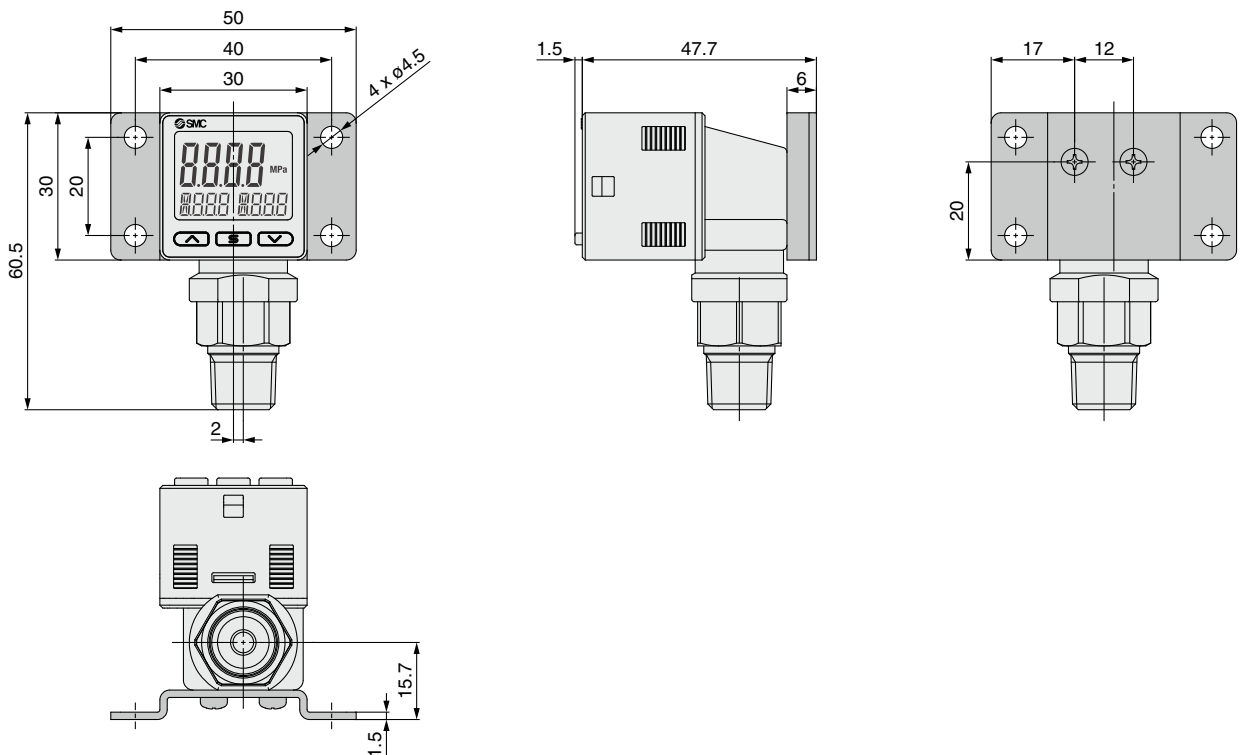

ZSE20(F)
ISE20

ZSE20A(F)
ISE20A

ZSE20B(F)
ISE20B

ZSE20B(F)-L
ISE20B-L

ZSE20C(F)
ISE20C(H)

ZSE20C(F)-L
ISE20C(H)-L

Function
Details

Made to
Order

Dimensions

Panel mount adapter

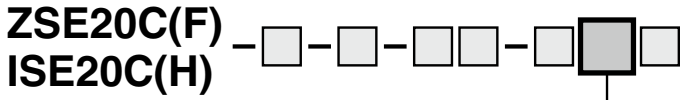

• Option 2

D

Panel mount adapter + Front protection cover (Rear ported)
 (Part no.: ZS-46-D)

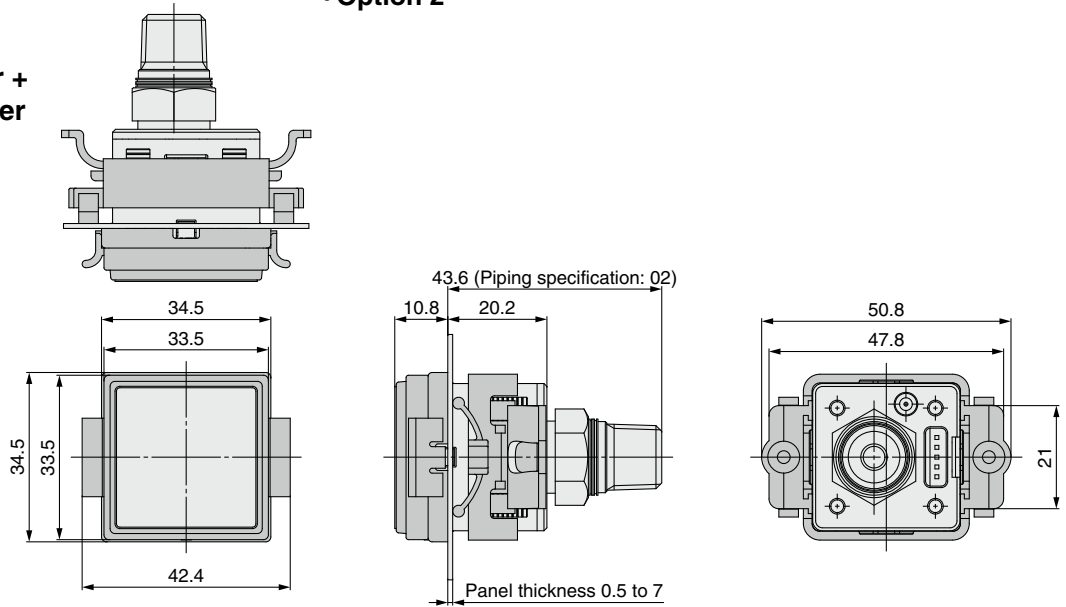

F

Panel mount adapter + Front protection cover (Bottom ported)
 (Part no.: ZS-35-E)

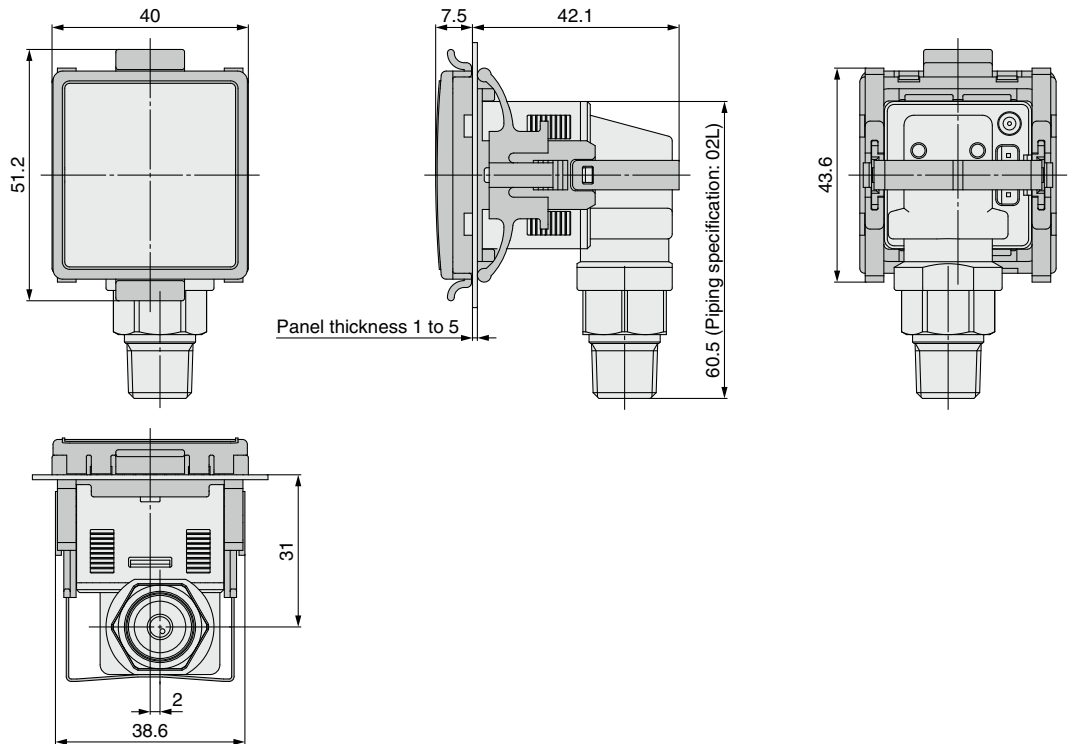

Lead wire with connector: For ZSE20C(F)/ISE20C(H)
 (Part no.: ZS-46-5F)

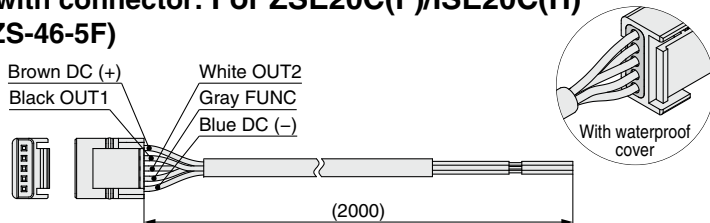

* For the lead wire with M12 connector, refer to page 43.

ZSE20(F)
ISE20

ZSE20A(F)
ISE20A

ZSE20B(F)
ISE20B

ZSE20B(F)-L
ISE20B-L

ZSE20C(F)
ISE20C(H)

ZSE20C(F)-L
ISE20C(H)-L

Function
Details

Made to
Order

ZSE20C(F)/ISE20C(H) Series

Dimensions

Panel fitting dimensions (Rear ported)

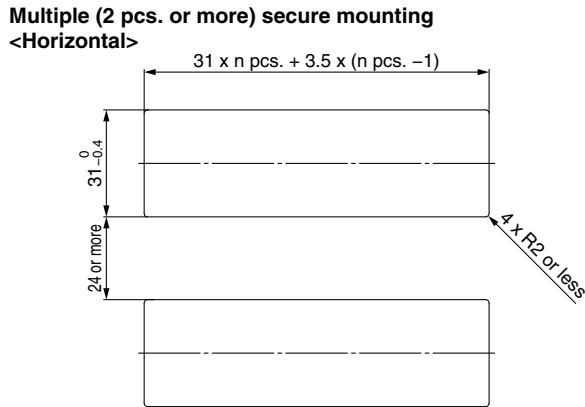
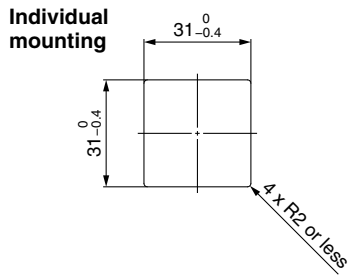

**Panel mount example
<Horizontal>**

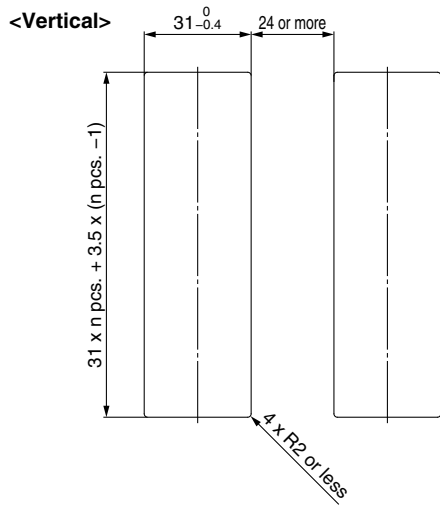
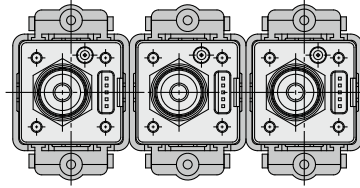

**Panel mount example
<Vertical>**

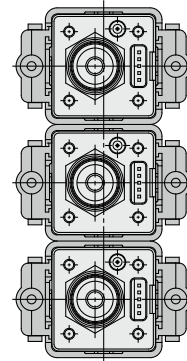

Panel fitting dimensions (Bottom ported)

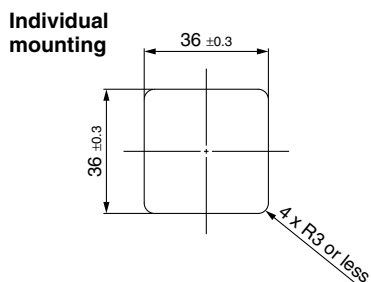

**Multiple (2 pcs. or more) secure mounting
<Horizontal>**

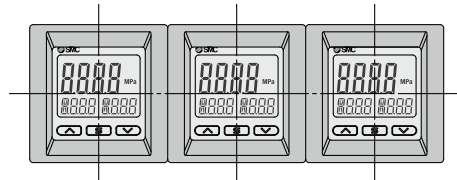
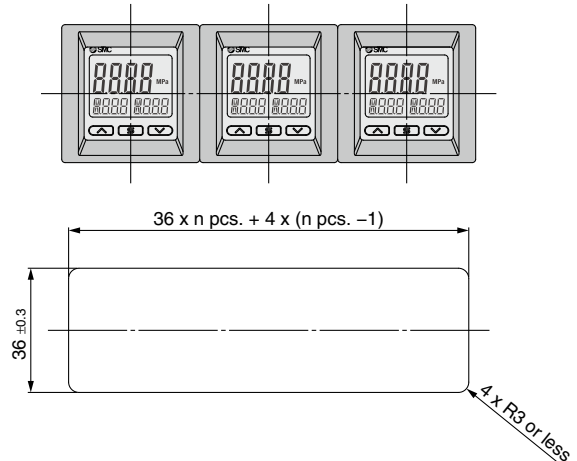

ZSE20□(F)/ISE20□ Series Function Details

Display examples of the main and sub (set value) screens of each mode. (For ISE20□ (for Positive pressure))

Hysteresis mode Normal output

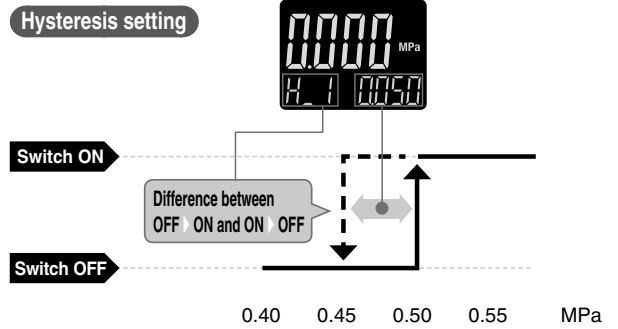
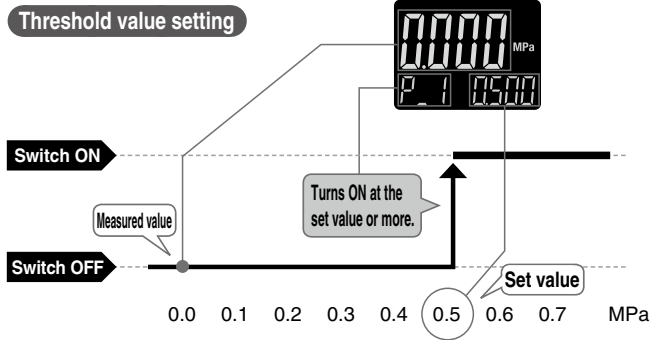

Hysteresis mode Reversed output

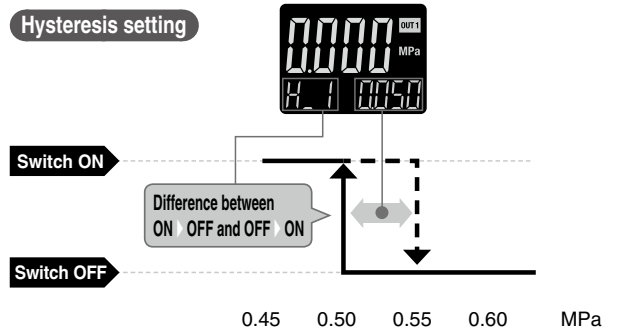
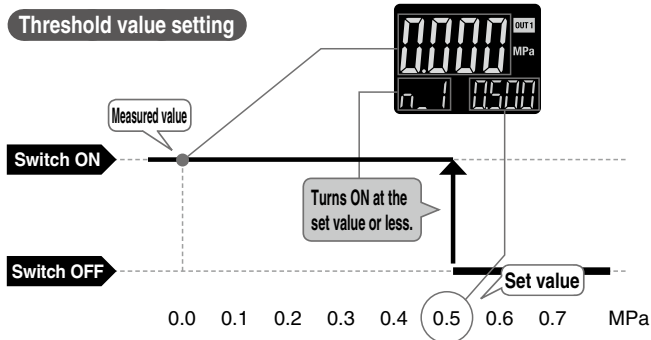

Window comparator mode Normal output

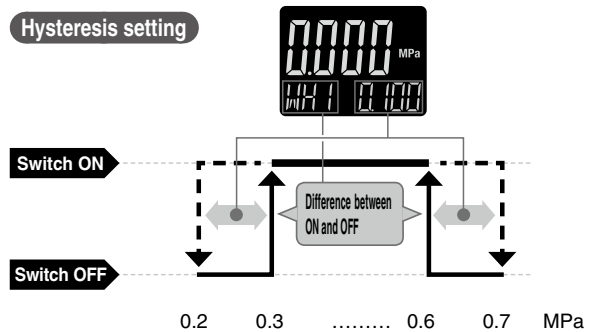
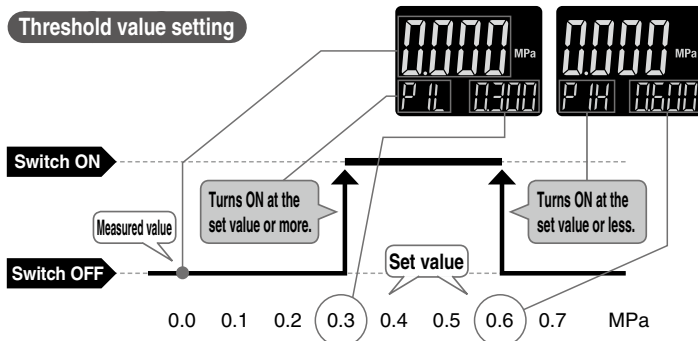

Window comparator mode Reversed output

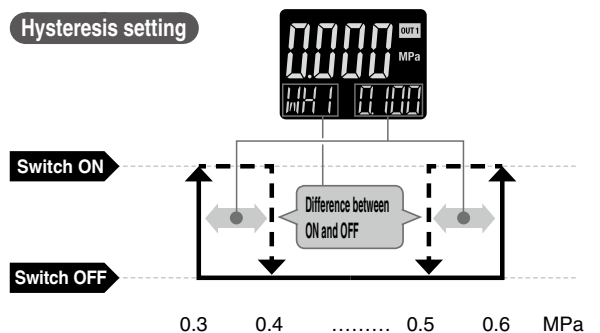
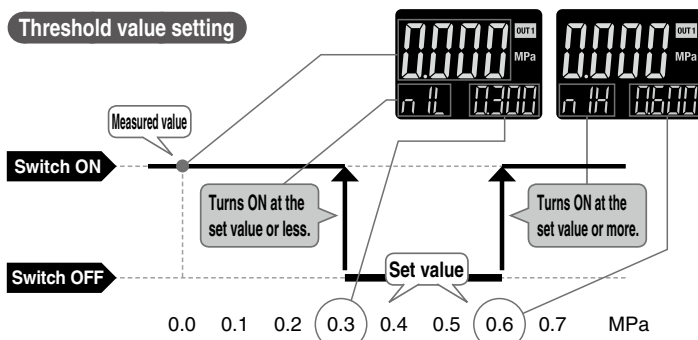

ZSE20(F)
ISE20

ZSE20A(F)
ISE20A

ZSE20B(F)
ISE20B

ZSE20B(F)-L
ISE20B-L

ZSE20C(F)
ISE20C(H)

ZSE20C(F)-L
ISE20C(H)-L

Function
Details

Made to
Order

The F□ in () shows the function code number. For details about operation procedures and function codes, refer to the “Operation Manual” on the SMC website.



Function Details

A Auto-preset function (F4)

This function, when selected in the initial setting, calculates and stores the set value from the measured pressure. For example, if this function is used for suction verification, the optimum set value is determined automatically by performing suction and release of several workpieces.

Suction Verification

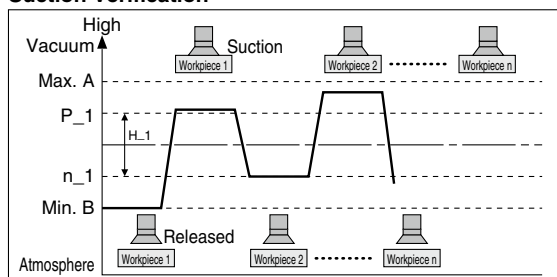

* When using with IO-Link, the set values cannot be changed by communication.

Formula for Obtaining the Set Value

| P_1 or n_1 | H_1 |
|-------------------------|-----------------------|
| $P_1 = A - (A - B) / 4$ | $H_1 = (A - B) / 2 $ |
| $n_1 = B + (A - B) / 4$ | |

B Display value fine adjustment function (F6)

Fine adjustment of the indicated value of the pressure sensor can be made within the range of $\pm 5\%$ of the read value. (This eliminates wide variations of the indicated value.)

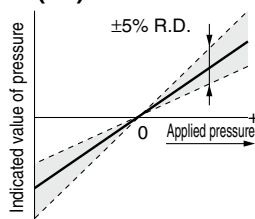

— Indicated value at the time of shipment
 ■ Adjustable range of display value fine adjustment function

* When the display value fine adjustment function is used, the set pressure value may change ± 1 digit.

C Peak/Bottom value display

This function constantly detects and updates the maximum (minimum) pressure when the power is supplied, and allows to hold the maximum (minimum) pressure value.

The held value is maintained even if the power supply is cut.

When the and buttons are simultaneously pressed for 1 second or longer, while “holding”, the held value will be reset.

D Key-lock function

This function prevents operation errors such as accidentally changing setting values.

E Zero-clear function

This function clears and resets the zero value on the display of measured pressure.

The indicated value can be adjusted within $\pm 7\%$ F.S. of the pressure at the time of shipment from the factory. (ZSE20□F (for compound pressure): $\pm 3.5\%$ F.S.)

F Error display function

When an error or abnormality arises, the location and contents are displayed.

| Error name | Error code | Description | Action |
|------------------------------|------------|--|--|
| Over current error | | A load current of 80 mA or more is applied to the switch output. | Eliminate the cause of the over current by turning off the power supply and then turn it on again. |
| Residual pressure error | | During zero-clear operation, pressure over $\pm 7\%$ F.S. ($\pm 3.5\%$ F.S. for compound pressure) is present. Note that the mode is returned to measurement mode automatically 1 second later. The zero-clear range varies by $\pm 1\%$ F.S. due to variation between individual products. | Perform zero-clear operation again after restoring the applied pressure to an atmospheric pressure condition. |
| Applied pressure error | | Supply pressure exceeds the maximum set pressure. | Reset applied pressure to a level within the set pressure range |
| | | Supply pressure is below the minimum set pressure. | |
| System error | | An internal data error has occurred. | Turn the power off and then on again. If the error cannot be solved, please contact SMC for investigation. |
| Copy error | | The copy function does not operate properly. | After clearing the error by pressing the and buttons simultaneously for a minimum of 1 second, check the wiring and the model, and then attempt to copy again. |
| IO-Link master version error | | The IO-Link version does not match that of the master. | Ensure that the master IO-Link version matches the device version. |

If the error cannot be solved after the instructions above are performed, or errors other than those above are displayed, please contact SMC for investigation.



The F□ in () shows the function code number. For details about operation procedures and function codes, refer to the “Operation Manual” on the SMC website.

Function Details

G Anti-chattering function (Simple setting mode or F1, F2)

A large bore cylinder or ejector consumes a large volume of air during operation and may experience a temporary drop in the supply pressure. This function prevents detection of such temporary drops in the supply pressure as an error by changing the delay time setting.

| Available delay time settings |
|--|
| 1.5 ms or less, 20 ms, 100 ms, 500 ms, 1000 ms, 2000 ms, 5000 ms |

<Principle>

This function averages pressure values measured during the response time set by the user and then compares the average pressure value with the pressure set point value to output the result on the switch.

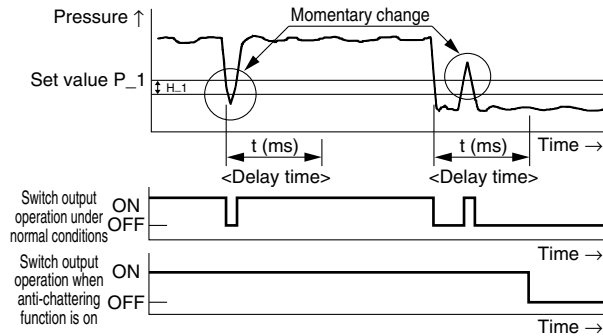

H Units selection function (F0)

Display units can be switched with this function.

| Display unit | MPa | kPa | kGF | bAr | PSi | inCH | mmHG |
|-----------------------------|-------|-----|---------------------|-------|------|------|------|
| Smallest settable increment | MPa*1 | kPa | kgf/cm ² | bar | psi | inHg | mmHg |
| ZSE20□ (Vacuum pressure) | 0.001 | 0.1 | 0.001 | 0.001 | 0.01 | 0.1 | 1 |
| ZSE20□F (Compound pressure) | 0.001 | 0.1 | 0.001 | 0.001 | 0.02 | 0.1 | 1 |
| ISE20□ (Positive pressure) | 0.001 | 1 | 0.01 | 0.01 | 0.1 | | |
| ISE20□H (Positive pressure) | 0.001 | 1 | 0.01 | 0.01 | 0.2 | | |

*1 The ZSE20□ (vacuum pressure) and ZSE20□F (compound pressure) will have different setting and display resolution when the unit is set to MPa.

I Selection of power saving mode (F80)

The power saving mode can be selected.

With this function, if no buttons are pressed for 30 s, it shifts to power saving mode.

At the time of shipment from the factory, the product is set to the normal mode (the power saving mode is turned off).

(During power saving mode, [ECo] will flash in the sub screen and the operation light will be ON (only when the switch is ON).)

J Setting of security code (F81)

The user can select whether a security code must be entered to release the key lock.

At the time of shipment from the factory, it is set such that a security code is not required.

ZSE20(F)
ISE20

ZSE20A(F)
ISE20A

ZSE20B(F)
ISE20B

ZSE20B(F)-L
ISE20B-L

ZSE20C(F)
ISE20C(H)

ZSE20C(F)-L
ISE20C(H)-L

Function
Details

Made to
Order

ZSE20□(F)/ISE20□ Series

The F□ in () shows the function code number. For details about operation procedures and function codes, refer to the “Operation Manual” on the SMC website.



Function Details

K Copy function (F97) (Z/ISE20A, 20B, 20C series only)

The set values of the sensor can be copied.
This can reduce setting labor and minimize the risk of setting mistakes.
The set value can be copied to up to 10 switches simultaneously.
(Maximum transmission distance: 4 m)

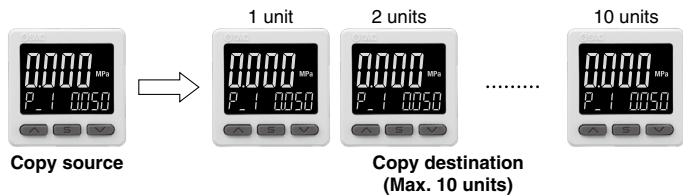

* This function is not provided with the IO-Link compatible type.

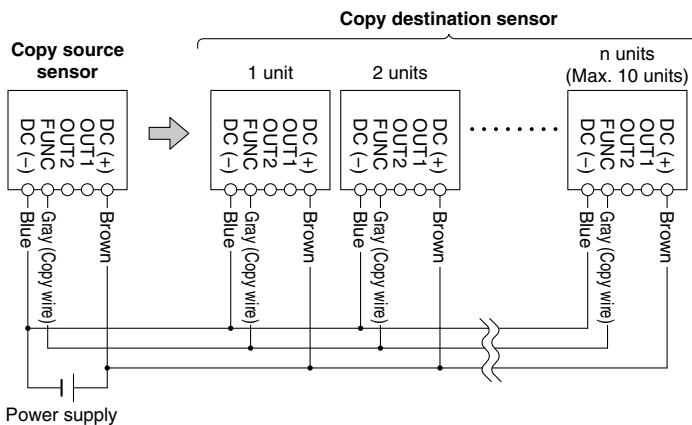

- 1) Wire as shown in the figure on the left.
- 2) All sensors are set to copy destination when first purchased. (Default condition is the sensor to be copied to.)
- 3) Press the **S** button on the source sensor to start copying.

L Auto-shift function (F5) (Z/ISE20A, 20B, 20C series only)

When there are large fluctuations in the supply pressure, the switch may fail to operate correctly. The auto-shift function compensates for such supply pressure fluctuations. It measures the pressure at the time of auto-shift signal input and uses it as the reference pressure to correct the set value on the switch.

Set value correction by auto-shift function

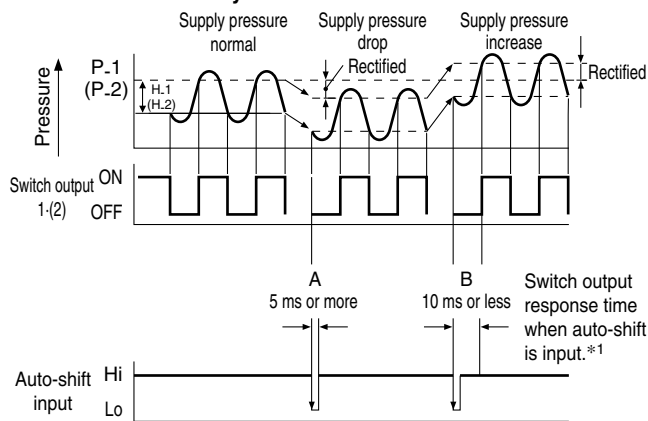

*1 When delay time is 1.5 ms or less

When the auto-shift function is selected, “RS in 000” will be displayed on the sub screen for about 1 second, and the pressure value at that point will be saved as reference value “E_5.” Based on the saved reference value, output on-off points controlled by set values*2 such as “P_1,” “H_1,” “P_2,” and “H_2” will also be rectified.

*2 When an output is reversed, output on-off points displayed at “n_1,” “H_1,” “n_2,” and “H_2” will be rectified.

The above is an example in hysteresis mode. On-off points are similarly rectified in window comparator mode. Outputs that enable the auto-shift function can be changed via the settings.

* This function is not provided with the IO-Link compatible type.

Settable Range for Auto-Shift Input

| | Set pressure range | Settable range |
|---------------------|---------------------|---------------------|
| Compound pressure | -105.0 to 105.0 kPa | -210 to 210 kPa |
| Vacuum pressure | 10.0 to -105.0 kPa | 115.0 to -115.0 kPa |
| Positive pressure | -0.105 to 1.050 MPa | -1.155 to 1.155 MPa |
| Positive pressure*3 | -0.105 to 2.100 MPa | -2.20 to 2.205 MPa |

*3 Z/ISE20C series only

Auto-shift zero

The basic function of auto-shift zero is the same as that of auto-shift. However, it corrects values on the display based on a pressure value of “0”, which is set as the reference value when auto-shift function is selected.

ZSE20□(F)/ISE20□ Series Made to Order



Please contact SMC for detailed dimensions, specifications, and delivery times.

1 Parts in Contact with Fluid: Stainless Steel 316L

20C

This pressure switch has better corrosion resistance because it uses stainless steel 316L for the parts in contact with fluid (pressure sensor and fitting).

How to Order

ZSE20C(F)/ISE20C - □ - □ - □ - □ - □ - □ - X500

Enter the standard product number. (p. 25)

- * Not applicable to the rated pressure -0.1 to 2 MPa specifications (ISE20CH)
- * A restrictor (equivalent to -X510) is installed inside the fitting. (Piping specifications A2(L) and B2(L) are excluded.)

Specifications

| Model | ZSE20C(F) | ISE20C |
|--------------------|--|---------|
| Withstand pressure | 500 kPa | 1.5 MPa |
| Applicable fluid | Liquids and gases that do not corrode stainless steel 316L | |

Models other than those above have the same specifications as the standard product.

2 Restrictor-installed Fitting

20C

A restrictor is installed inside the fitting in order to reduce the effects of water collision with inertia force in the piping when adsorption is broken.

How to Order

ZSE20C(F)/ISE20C(H) - □ - □ - □ - □ - □ - □ - X510

Enter the standard product number. (p. 25)

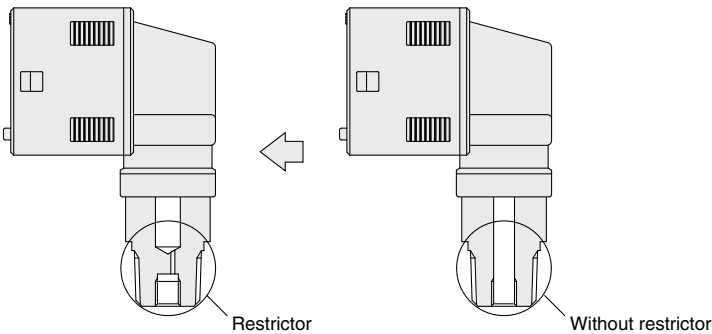

Made to Order: "-X510"

Standard

- * Not applicable for piping specifications A2(L) and B2(L)
- * There are cases in which this product will not effectively suppress the effects of water hammer. It is advised that other measures be taken in such cases.

3 Grease-free

20

20A

20B

This is a grease-free product.

- * The grease-free specification does not intentionally apply grease to the parts in contact with fluid.

ZSE20(F)/ISE20 - □ - □ - □ - □ - □ - □ - X2
 ZSE20A(F)/ISE20A - □ - □ - □ - □ - □ - □ - X2
 ZSE20B(F)/ISE20B - □ - □ - □ - □ - □ - □ - X2

Enter the standard product number. (pp. 9, 11, 13)

- * The ZSE20C(F) and the ISE20C(H) are grease-free specifications as standard.

ZSE20(F)
ISE20

ZSE20A(F)
ISE20A

ZSE20B(F)
ISE20B

ZSE20B(F)-L
ISE20B-L

ZSE20C(F)
ISE20C(H)

ZSE20C(F)-L
ISE20C(H)-L

Function
Details

Made to
Order

ZSE20□(F)/ISE20□ Series

Please contact SMC for detailed dimensions, specifications, and delivery times.

4 3 m Lead Wire

20B

20C

This product features a lead wire which is 3 m in length.

ZSE20B(F)/ISE20B - □ - □ - □ - W □ □ - X500
 ZSE20C(F)/ISE20C - □ - □ - □ - W □ □ - X502

Enter the standard product number. (pp. 13, 25) •

5 M8 3-pin Pre-wired Connector (Lead wire length: 500 mm)

20B

ZSE20B(F)/ISE20B - X - □ - □ - W □ □ - X503

Output specification •

• Enter the standard product number. (p. 13)

| Symbol | Description |
|--------|---------------------------------|
| X | NPN 2 outputs (+ Copy function) |
| Y | PNP 2 outputs (+ Copy function) |

* As the product body is shipped with the copy function enabled, simply replace the standard product cable with this cable.

6 M12 4-pin Pre-wired Connector (Lead wire length: 100 mm)

20A

20B

20C

ZSE20A(F)/ISE20A - X - □ - □ - J □ □ - X505
 ZSE20B(F)/ISE20B - X - □ - □ - W □ □ - X505
 ZSE20C(F)/ISE20C - X - □ - □ - W □ □ - X505

Output specification •

• Enter the standard product number. (pp. 11, 13, 25)

| Symbol | Description |
|--------|---------------------------------|
| X | NPN 2 outputs (+ Copy function) |
| Y | PNP 2 outputs (+ Copy function) |

* As the product body is shipped with the copy function enabled, simply replace the standard product cable with this cable.

Optional lead wire part number: ZS-46-5FM12 (ZS-46-5LM12: Non-waterproof type)

Connector pin assignment

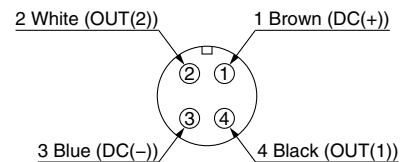
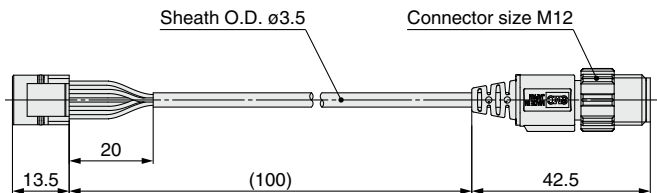

7 Lead Wire with Connector (Terminal cover)

20

20A

By using a waterproof lead wire for the connector portion, terminal exposure can be prevented.

ZSE20(F)/ISE20 - □ - □ - □ - L □ □ - X531
 ZSE20A(F)/ISE20A - □ - □ - □ - J □ □ - X531

Enter the standard product number. (pp. 9, 11) •

Please contact SMC for detailed dimensions, specifications, and delivery times.

8 Conversion Cable for the Z/ISE30A Lead Wire with Connector

20

20A

The conversion cable allows for connection between the existing Z/ISE30A lead wire with connector and the Z/ISE20.

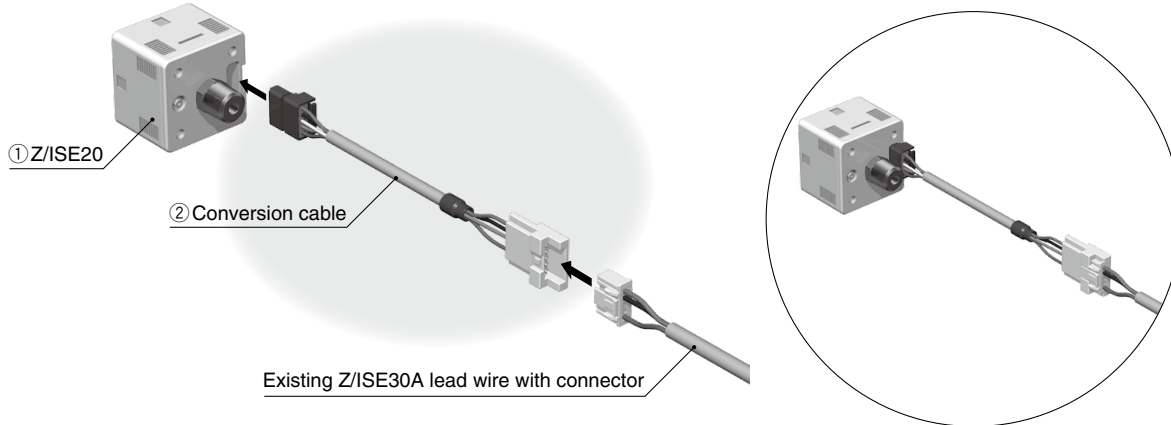

The output specification symbol may vary from that of the existing pressure switch.

Z/ISE30A → Z/ISE20 + Conversion Cable Correspondence Table

| Existing digital pressure switch model | Output specification | ① Pressure switch part no. | ② Conversion cable part no. |
|--|---|----------------------------|-----------------------------|
| Z/ISE30A-□-N-□□□□ | NPN open collector 1 output | Z/ISE20-N-□-□-□□□□ | ZS-46-5LA-X424*1 |
| Z/ISE30A-□-P-□□□□ | PNP open collector 1 output | Z/ISE20-P-□-□-□□□□ | |
| Z/ISE30A-□-A-□□□□ | NPN open collector 2 outputs | Z/ISE20A-X-□-□-□□□□ | |
| Z/ISE30A-□-B-□□□□ | PNP open collector 2 outputs | Z/ISE20A-Y-□-□-□□□□ | |
| Z/ISE30A-□-C-□□□□ | NPN open collector 1 output + Analog voltage output | Z/ISE20A-R-□-□-□□□□ | ZS-46-5LB-X424*1 |
| Z/ISE30A-D-□□□□ | NPN open collector 1 output + Analog current output | Z/ISE20A-S-□-□-□□□□ | |
| Z/ISE30A-E-□□□□ | PNP open collector 1 output + Analog voltage output | Z/ISE20A-T-□-□-□□□□ | |
| Z/ISE30A-F-□□□□ | PNP open collector 1 output + Analog current output | Z/ISE20A-V-□-□-□□□□ | |

*1 While this conversion cable allows for use of the existing wiring, output and functions other than that of the Z/ISE30A will be invalid (not wired).

ZS-46-5LA-X424

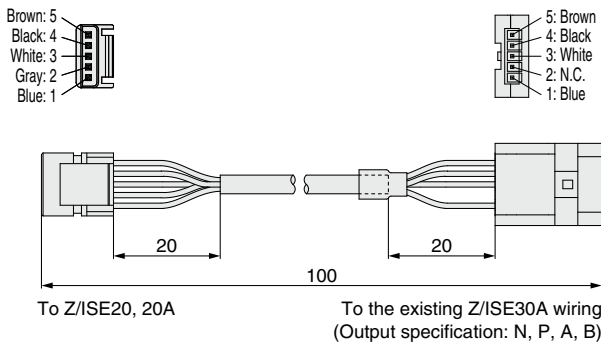

ZS-46-5LB-X424

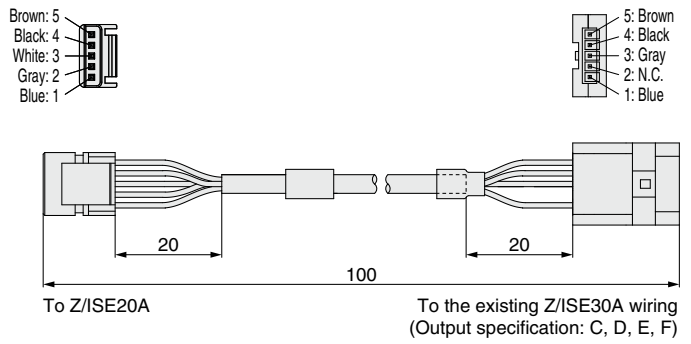

9 With Spacer for Fitting Extension

20

20A

20B

Allows for the easier insertion and removal of the lead wire with connector by extending the piping fitting
Part number for the spacer for extension: **ZS-46-M5A**

ZSE20(F)/ISE20 - □ - □ - 01 - □ □ □ - X532
 ZSE20A(F)/ISE20A - □ - □ - 01 - □ □ □ - X532
 ZSE20B(F)/ISE20B - □ - □ - 01 - □ □ □ - X532

Enter the standard product number.
(pp. 9, 11, 13)

● Piping specification

| Symbol | Description |
|--------|-------------|
| 01 | R1/8 |
| N01 | NPT1/8 |

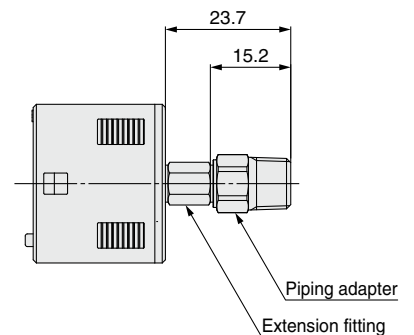

ZSE20(F)
ISE20

ZSE20A(F)
ISE20A

ZSE20B(F)
ISE20B

ZSE20B(F)-L
ISE20B-L

ZSE20C(F)
ISE20C(H)

ZSE20C(F)-L
ISE20C(H)-L

Function
Details

Made to
Order

ZSE20□(F)/ISE20□ Series

Please contact SMC for detailed dimensions, specifications, and delivery times.

10 □36 mm Panel Hole (Compatible with the panel holes of the Z/ISE40A and Z/ISE80) 20B 20C

This specification includes a panel mount adapter for the mounting holes of the panel mount used by the Z/ISE40A and Z/ISE80.

| Symbol | Description |
|----------|--|
| B | Panel mount adapter |
| D | Panel mount adapter + Front protection cover |

Option 2 ●

ZSE20B(F)/ISE20B - □ - □ - □ - □ **B** □ - X521

ZSE20C(F)/ISE20C - □ - □ - □ - □ **B** □ - X521

Enter the standard product number. (pp. 13, 25) ●

Compatible with the panel holes of the Z/ISE40A

B
Panel mount adapter
(Part no.: ZS-46-F)

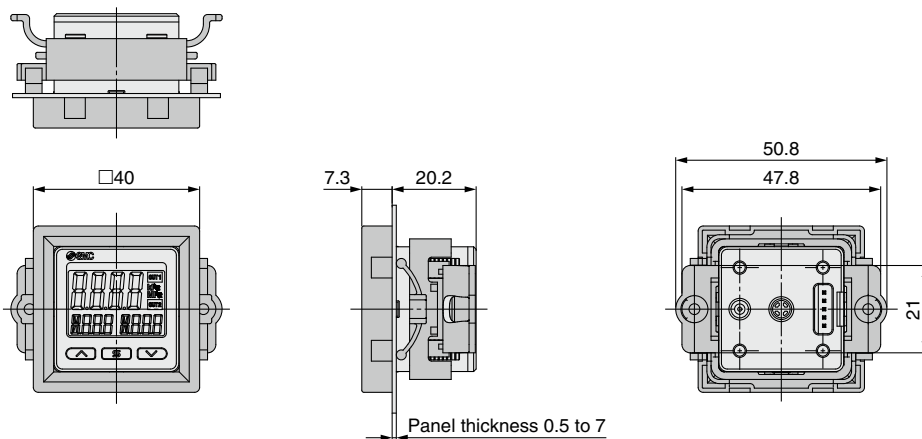

D
Panel mount adapter +
Front protection cover
(Part no.: ZS-46-G)

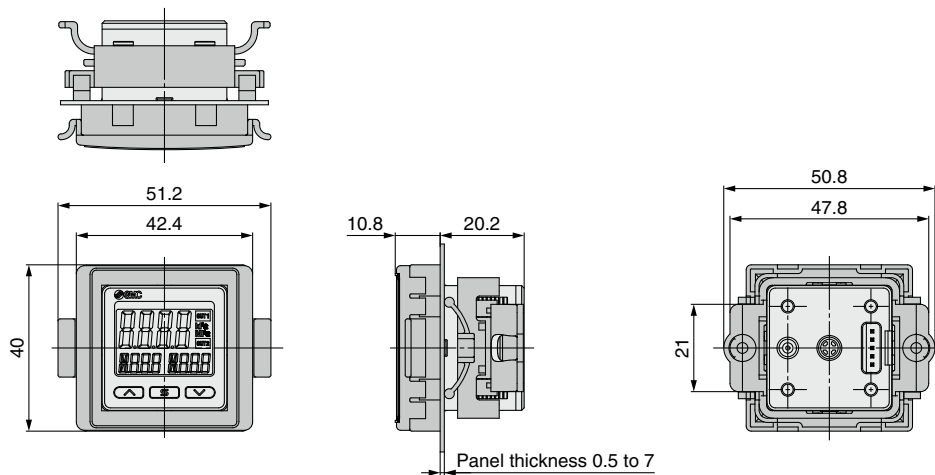

Panel fitting dimensions

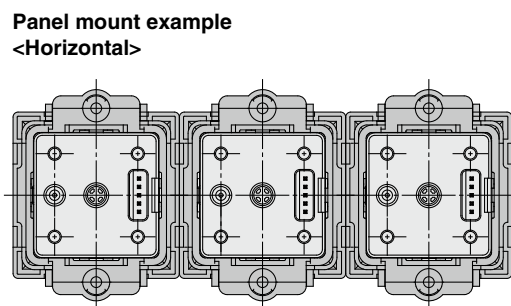
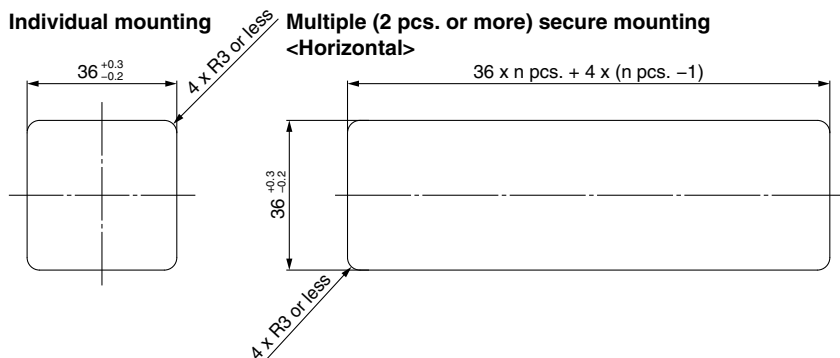

Please contact SMC for detailed dimensions, specifications, and delivery times.

10 □36 mm Panel Hole (Compatible with the panel holes of the Z/ISE40A and Z/ISE80)

20B

20C

Compatible with the panel holes of the Z/ISE80

B

Panel mount adapter
(Rear ported)
(Part no.: ZS-46-F)

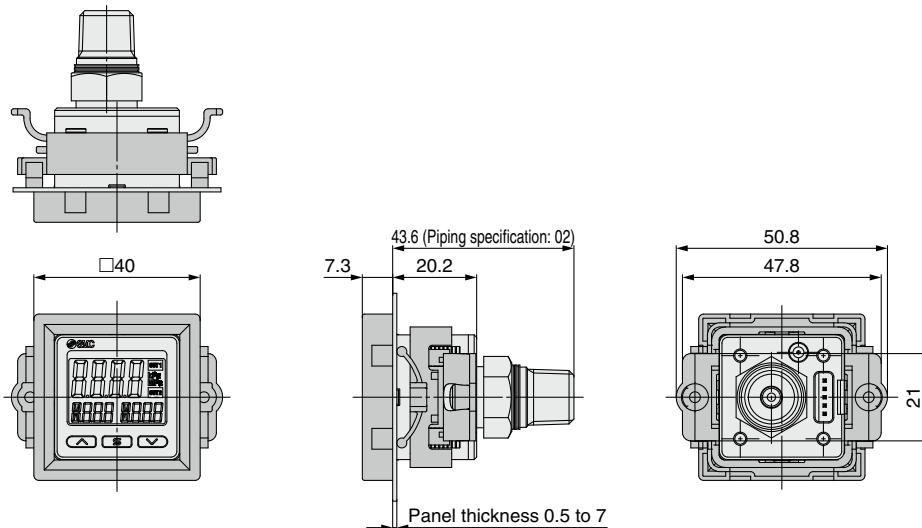

D

Panel mount adapter +
Front protection cover
(Rear ported)
(Part no.: ZS-46-G)

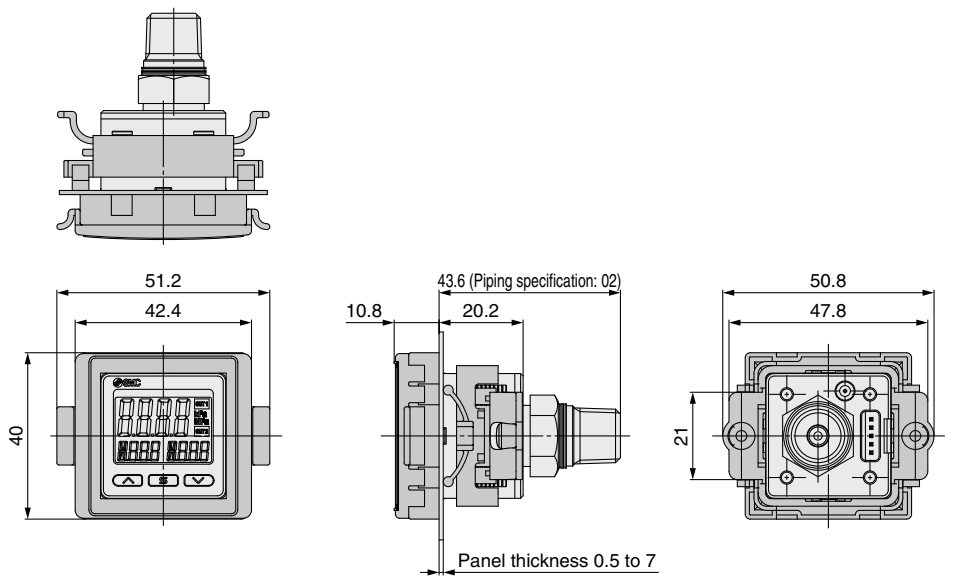

Panel fitting dimensions (Rear ported)

Individual mounting

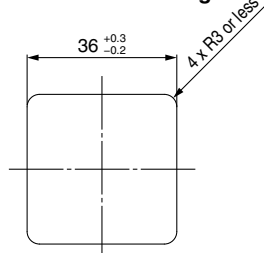

Multiple (2 pcs. or more) secure mounting
<Horizontal>

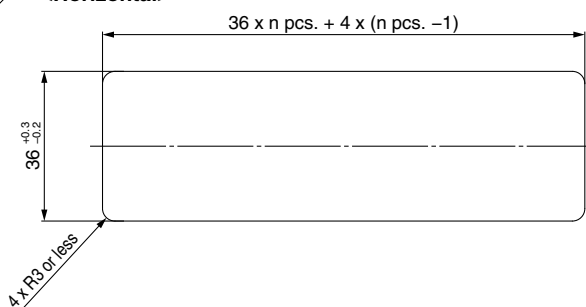

Panel mount example
<Horizontal>

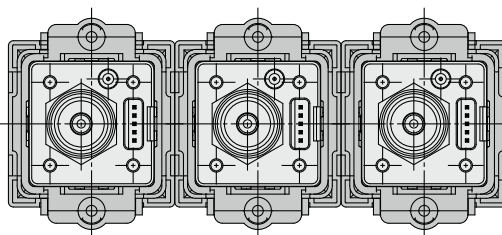

ZSE20(F)
ISE20

ZSE20A(F)
ISE20A

ZSE20B(F)
ISE20B

ZSE20B(F)-L
ISE20B-L

ZSE20C(F)
ISE20C(H)

ZSE20C(F)-L
ISE20C(H)-L

Function
Details

Made to
Order

ZSE20□(F)/ISE20□ Series

Please contact SMC for detailed dimensions, specifications, and delivery times.

11 Pressure Switch (for Low Pressure)

20A

Able to detect and display pressures of 10 kPa or less

How to Order

ZSE20AF - **A** - **M** - **M5** - □ - □ - □ - **X576**

①
②
③
④
⑤
⑥
⑦

① Output specification

| Symbol | Description |
|----------|---|
| A | NPN open collector 2 outputs + Copy function |
| B | PNP open collector 2 outputs + Copy function |
| C | NPN open collector 1 output + Analog voltage output + External zero-clear*1 |
| D | NPN open collector 1 output + Analog current output + External zero-clear*1 |

*1 Can be switched to copy function

② Unit specification

| Symbol | Description |
|------------|----------------------------|
| Nil | Units selection function*1 |
| M | SI units only*2 |

*1 Under the New Measurement Act, switches with the units selection function are no longer allowed for use in Japan.

*2 Fixed units: kPa, Pa

③ Piping specification

| Symbol | Description |
|-----------|------------------|
| M5 | M5 female thread |

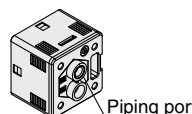

④ Option 1

| Symbol | Description |
|------------|--|
| Nil | Without lead wire |
| J | Lead wire with connector (5-core, 2 m lead wire) |

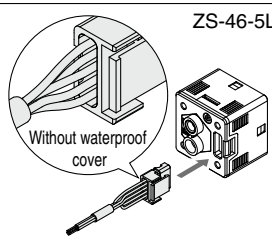

* For the lead wire with M12 connector, refer to page 43.

⑤ Option 2

| Symbol | Description |
|------------|--|
| Nil | None |
| A1 | Bracket A (Vertical mounting) |
| A2 | Bracket B (Horizontal mounting) |
| B | Panel mount adapter |
| D | Panel mount adapter + Front protection cover |

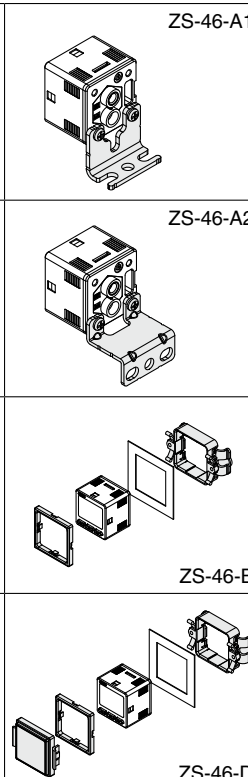

⑥ Option 3

| Symbol | Calibration certificate |
|------------|-------------------------|
| Nil | — |
| K | ○ |

⑦ Rated pressure range

| Symbol | Description |
|-------------|---------------------|
| X576 | -500 to 500 Pa |
| X577 | -1.000 to 1.000 kPa |
| X578 | -2.00 to 2.00 kPa |
| X579 | -5.00 to 5.00 kPa |
| X580 | -10.00 to 10.00 kPa |

Options/Part Nos.

When only optional parts are required, order with the part numbers listed below

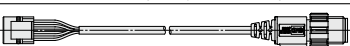
| Description | Part no. | Note |
|--|--------------------|--|
| Bracket A | ZS-46-A1 | Tapping screw: Nominal size 3 x 8 L (2 pcs.) |
| Bracket B | ZS-46-A2 | Tapping screw: Nominal size 3 x 8 L (2 pcs.) |
| Panel mount adapter | ZS-46-B | — |
| Panel mount adapter + Front protection cover | ZS-46-D | — |
| Lead wire with connector | ZS-46-5L | 5-core, 2 m, Non-waterproof (Without waterproof cover) |
| Lead wire with M12 connector | ZS-46-5LM12 |  Made to order (Refer to page 43.) |
| Front protection cover | ZS-27-01 | — |

Please contact SMC for detailed dimensions, specifications, and delivery times.

11 Pressure Switch (for Low Pressure)

20A

Specifications

| Model | | X576 | X577 | X578 | X579 | X580 |
|---------------------------------|--|--|---------------------|-------------------|--|---------------------|
| Applicable fluid | | Air, Non-corrosive gas, Non-flammable gas | | | | |
| Pressure | Rated pressure range | -500 to 500 Pa | -1.000 to 1.000 kPa | -2.00 to 2.00 kPa | -5.00 to 5.00 kPa | -10.00 to 10.00 kPa |
| | Display/Set pressure range | -525 to 525 Pa | -1.050 to 1.050 kPa | -2.10 to 2.10 kPa | -5.25 to 5.25 kPa | -10.50 to 10.50 kPa |
| | Display/Smallest settable increment | 1 Pa | 0.001 kPa | 0.01 kPa | 0.01 kPa | 0.01 kPa |
| | Withstand pressure | 2.5 kPa | 5 kPa | 10 kPa | 25 kPa | 50 kPa |
| Accuracy | Display accuracy | ±2% F.S. ±1 digit (Ambient temperature of 25°C ±3°C) | | | | |
| | Repeatability | ±1% F.S. ±1 digit | | | | |
| | Temperature characteristics | ±3% F.S. (25°C standard) | | | | |
| Switch output | Output type | NPN open collector output, PNP open collector output | | | | |
| | Max. load current | 80 mA | | | | |
| | Max. applied voltage (NPN only) | 28 V | | | | |
| | Internal voltage drop (Residual voltage) | 1.0 V or less (at load current of 80 mA) | | | | |
| | Delay time*1 | 4 ms or less, variable from 0 to 60 s/0.01 s increments | | | | |
| Analog output | *2 Voltage output Output voltage (Rated pressure range) | Voltage output: 1 to 5 V ±2.5% F.S. | | | | |
| | | Linearity | ±1.5% F.S. | | ±1.0% F.S. | |
| | | Output impedance | Approx. 1 kΩ | | | |
| | *3 Current output Output current (Rated pressure range) | Current output: 4 to 20 mA ±2.5% F.S. | | | | |
| | | Linearity | ±1.5% F.S. | | ±1.0% F.S. | |
| | | Load impedance | Max. load impedance | | at power supply voltage of 12 V: 300 Ω | |
| | | | Min. load impedance | | at power supply voltage of 24 V: 600 Ω | |
| | | | | : 50 Ω | | |
| Analog response time | | 20 ms | | | | |
| External zero-clear | Input type | Non-voltage input: 0.4 V or less, Current consumption: 5.5 mA or less | | | | |
| | Input time | 30 ms or more | | | | |
| Display | Unit*4 | kPa, Pa, mbar, psi, inchHg, mmHg, inchH ₂ O, mmH ₂ O | | | kPa, mbar, psi, inchHg, mmHg, inchH ₂ O, mmH ₂ O | |
| | Display type | LCD | | | | |
| | Number of screens | 3-screen display (Main screen, Sub screen x 2) | | | | |
| | Display color | 1) Main screen: Red/Green 2) Sub screen: Orange | | | | |
| | Number of display digits | 1) Main screen: 4 digits (7 segments) 2) Sub screen: 4 digits (Upper 1 digit 11 segments, 7 segments for other) | | | | |
| | Indicator light | Lights up when switch output is turned ON. OUT1, OUT2: Orange | | | | |
| Digital filter*5, *6 | Variable from 0 to 30 s/0.01 s increments | | | | | |
| Environmental resistance | Operating temperature range | Operating: -5 to 50°C, Stored: -10 to 60°C (No condensation) | | | | |
| | Operating humidity range | Operating/Stored: 35 to 85% RH (No condensation) | | | | |
| Standards | | UL/CSA (E216656), CE/UKCA marking | | | | |

- *1 Value without digital filter (at 0 ms)
- *2 Analog voltage output and analog current output cannot be selected at the same time.
- *3 Analog current output and analog voltage output cannot be selected at the same time.
- *4 Setting is only possible for models with the units selection function.
Only kPa or Pa is available for models without this function.
- *5 The response time indicates when the set value is 90% in relation to the step input.
- *6 Display, switch output, and analog response time are affected.
- * Products with tiny scratches, marks, or display color or brightness variations which do not affect the performance of the product are verified as conforming products.

For specifications other than those shown above, refer to page 12.

Dimensions

ZSE20AF - □ - □ - M5 - □ □ □ - X576 to X580

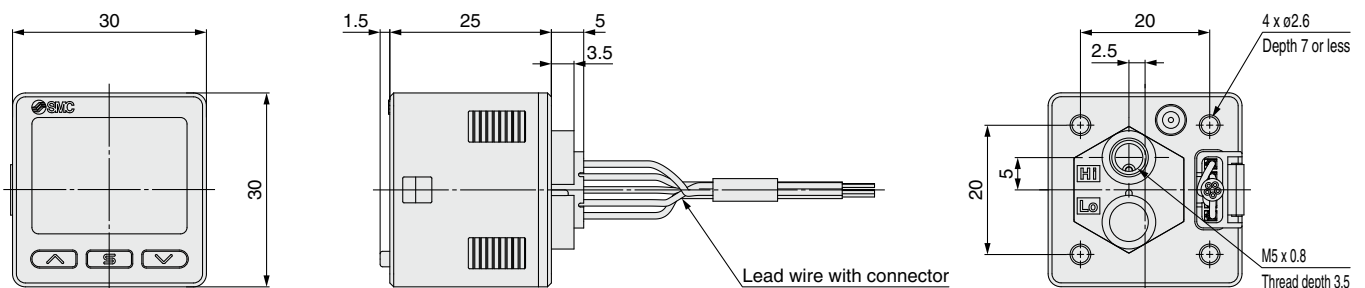

ZSE20(F)
ISE20

ZSE20A(F)
ISE20A

ZSE20B(F)
ISE20B

ZSE20B(F)-L
ISE20B-L

ZSE20C(F)
ISE20C(H)

ZSE20C(F)-L
ISE20C(H)-L

Function
Details

Made to
Order

Safety Instructions

These safety instructions are intended to prevent hazardous situations and/or equipment damage. These instructions indicate the level of potential hazard with the labels of “**Caution**,” “**Warning**” or “**Danger**.” They are all important notes for safety and must be followed in addition to International Standards (ISO/IEC)*1), and other safety regulations.

Caution: **Caution** indicates a hazard with a low level of risk which, if not avoided, could result in minor or moderate injury.

Warning: **Warning** indicates a hazard with a medium level of risk which, if not avoided, could result in death or serious injury.

Danger: **Danger** indicates a hazard with a high level of risk which, if not avoided, will result in death or serious injury.

*1) ISO 4414: Pneumatic fluid power – General rules relating to systems.
ISO 4413: Hydraulic fluid power – General rules relating to systems.
IEC 60204-1: Safety of machinery – Electrical equipment of machines.
(Part 1: General requirements)
ISO 10218-1: Manipulating industrial robots – Safety.
etc.

Warning

1. The compatibility of the product is the responsibility of the person who designs the equipment or decides its specifications.

Since the product specified here is used under various operating conditions, its compatibility with specific equipment must be decided by the person who designs the equipment or decides its specifications based on necessary analysis and test results. The expected performance and safety assurance of the equipment will be the responsibility of the person who has determined its compatibility with the product. This person should also continuously review all specifications of the product referring to its latest catalog information, with a view to giving due consideration to any possibility of equipment failure when configuring the equipment.

2. Only personnel with appropriate training should operate machinery and equipment.

The product specified here may become unsafe if handled incorrectly. The assembly, operation and maintenance of machines or equipment including our products must be performed by an operator who is appropriately trained and experienced.

3. Do not service or attempt to remove product and machinery/equipment until safety is confirmed.

1. The inspection and maintenance of machinery/equipment should only be performed after measures to prevent falling or runaway of the driven objects have been confirmed.
2. When the product is to be removed, confirm that the safety measures as mentioned above are implemented and the power from any appropriate source is cut, and read and understand the specific product precautions of all relevant products carefully.
3. Before machinery/equipment is restarted, take measures to prevent unexpected operation and malfunction.

4. Contact SMC beforehand and take special consideration of safety measures if the product is to be used in any of the following conditions.

1. Conditions and environments outside of the given specifications, or use outdoors or in a place exposed to direct sunlight.
2. Installation on equipment in conjunction with atomic energy, railways, air navigation, space, shipping, vehicles, military, medical treatment, combustion and recreation, or equipment in contact with food and beverages, emergency stop circuits, clutch and brake circuits in press applications, safety equipment or other applications unsuitable for the standard specifications described in the product catalog.
3. An application which could have negative effects on people, property, or animals requiring special safety analysis.
4. Use in an interlock circuit, which requires the provision of double interlock for possible failure by using a mechanical protective function, and periodical checks to confirm proper operation.

Caution

1. The product is provided for use in manufacturing industries.

The product herein described is basically provided for peaceful use in manufacturing industries.
If considering using the product in other industries, consult SMC beforehand and exchange specifications or a contract if necessary.
If anything is unclear, contact your nearest sales branch.

Limited warranty and Disclaimer/ Compliance Requirements

The product used is subject to the following “Limited warranty and Disclaimer” and “Compliance Requirements”.

Read and accept them before using the product.

Limited warranty and Disclaimer

1. The warranty period of the product is 1 year in service or 1.5 years after the product is delivered, whichever is first.*2)
Also, the product may have specified durability, running distance or replacement parts. Please consult your nearest sales branch.
2. For any failure or damage reported within the warranty period which is clearly our responsibility, a replacement product or necessary parts will be provided.
This limited warranty applies only to our product independently, and not to any other damage incurred due to the failure of the product.
3. Prior to using SMC products, please read and understand the warranty terms and disclaimers noted in the specified catalog for the particular products.

*2) Vacuum pads are excluded from this 1 year warranty.

A vacuum pad is a consumable part, so it is warranted for a year after it is delivered.
Also, even within the warranty period, the wear of a product due to the use of the vacuum pad or failure due to the deterioration of rubber material are not covered by the limited warranty.

Compliance Requirements

1. The use of SMC products with production equipment for the manufacture of weapons of mass destruction (WMD) or any other weapon is strictly prohibited.
2. The exports of SMC products or technology from one country to another are governed by the relevant security laws and regulations of the countries involved in the transaction. Prior to the shipment of a SMC product to another country, assure that all local rules governing that export are known and followed.

Caution

SMC products are not intended for use as instruments for legal metrology.

Measurement instruments that SMC manufactures or sells have not been qualified by type approval tests relevant to the metrology (measurement) laws of each country. Therefore, SMC products cannot be used for business or certification ordained by the metrology (measurement) laws of each country.

Revision History

Edition B * New variations (for general fluids, IP65, 2 outputs, and analog output) have been added.

* The number of pages has been increased from 16 to 36. VX

Edition C * An IO-Link compatible type has been added. (Z/ISE20B series)

* The number of pages has been increased from 36 to 40. WR

Edition D * Made to order options have been added.

* A One-touch fitting type has been added to the piping specifications.

* The number of pages has been increased from 40 to 44. YY

Edition E * An IO-Link compatible type has been added. (Z/ISE20C series)

* A low pressure range type has been added. (Z/ISE20A series)

* An M12 connector compatible type has been added. (Made to Order)

* The number of pages has been increased from 44 to 52.

Safety Instructions

Be sure to read the “Handling Precautions for SMC Products” (M-E03-3) and “Operation Manual” before use.

SMC Corporation

Akihabara UDX 15F,
4-14-1, Sotokanda, Chiyoda-ku, Tokyo 101-0021, JAPAN
Phone: 03-5207-8249 Fax: 03-5298-5362
<https://www.smcworld.com>
© 2023 SMC Corporation All Rights Reserved

Specifications are subject to change without prior notice and any obligation on the part of the manufacturer.